



Brilliant cut designs are the perfect way to decorate anything containing glass, from mirror wardrobes and framed mirrors to doors or double glazing. They reflect the light beautifully, add interest and the perceived value of the final product.

We can create your own personal design or multiple designs from lines, circles or scrolls using the latest computer technology.

This catalogue contains our most popular range of brilliant cut designs which are produced by grinding a 'V' shaped notch into the face of the glass which is then polished to a brilliant finish.

Brilliant cut designs can be cut into obscured glass to add an element of privacy for toilets and other private areas.

Where safety is a concern, brilliant cut designs can be supplied in both toughened and laminated glass complying to BS 6206.

For further advice on designs or prices,  
please contact our sales office.

BRILLIANT CUT, BEVELLED & POLISHED GLASS  
MIRRORS • PICTURE FRAMES • HARDWOOD DOORS

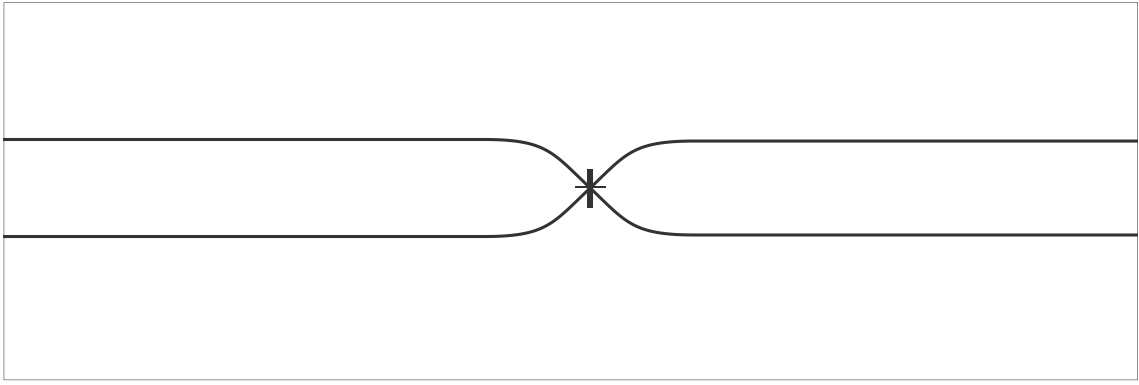

FGBC 1

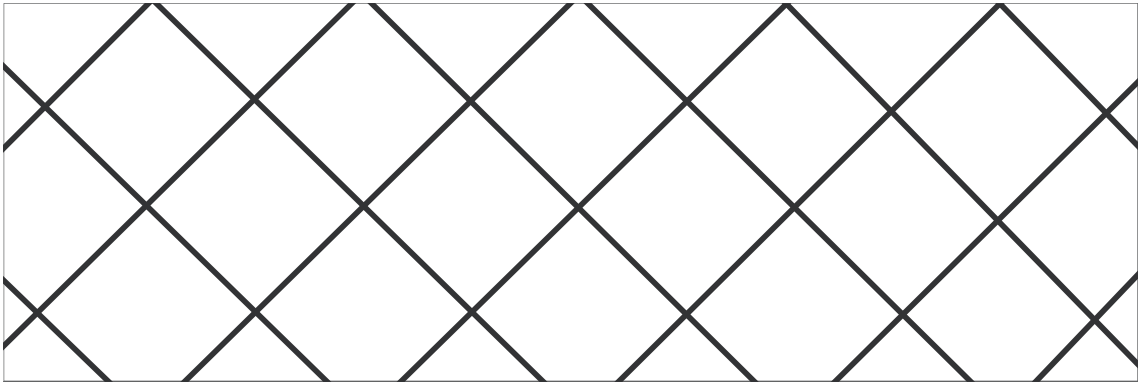

FGBC 2

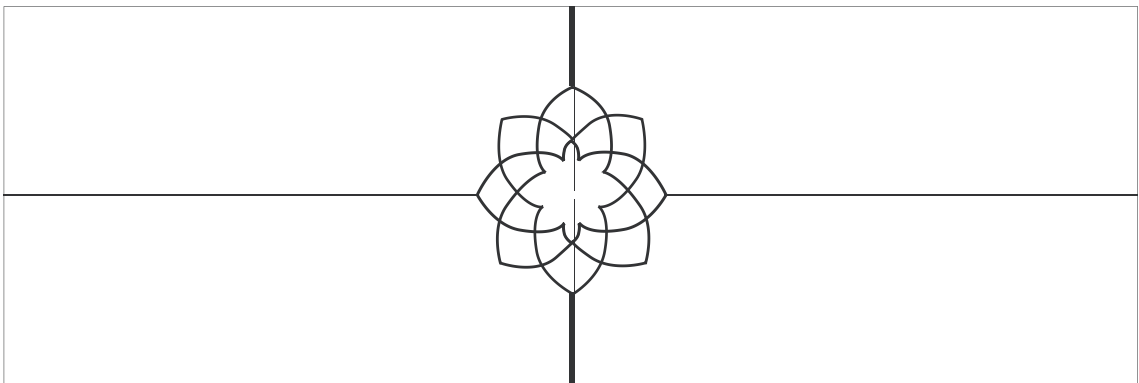

FGBC 3

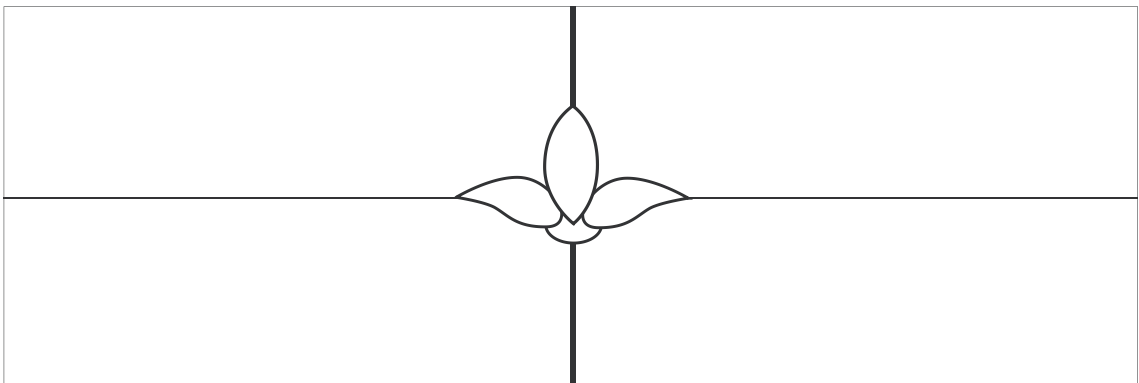

FGBC 4

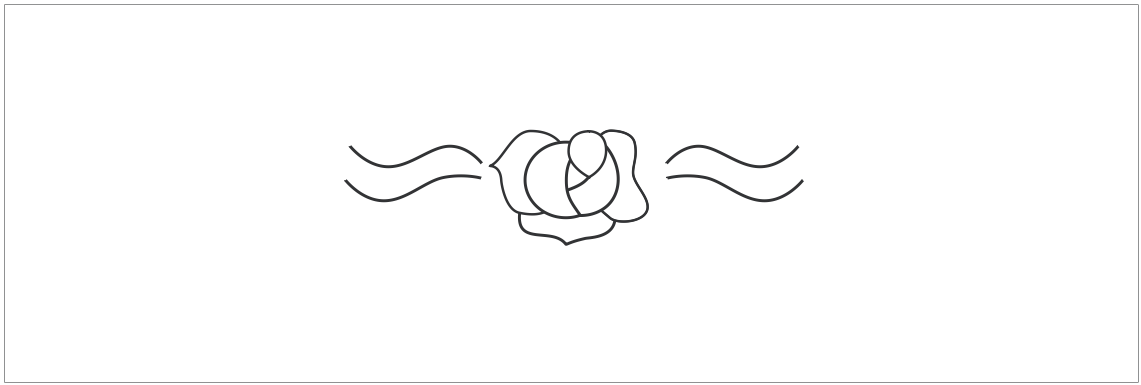

FGBC 5

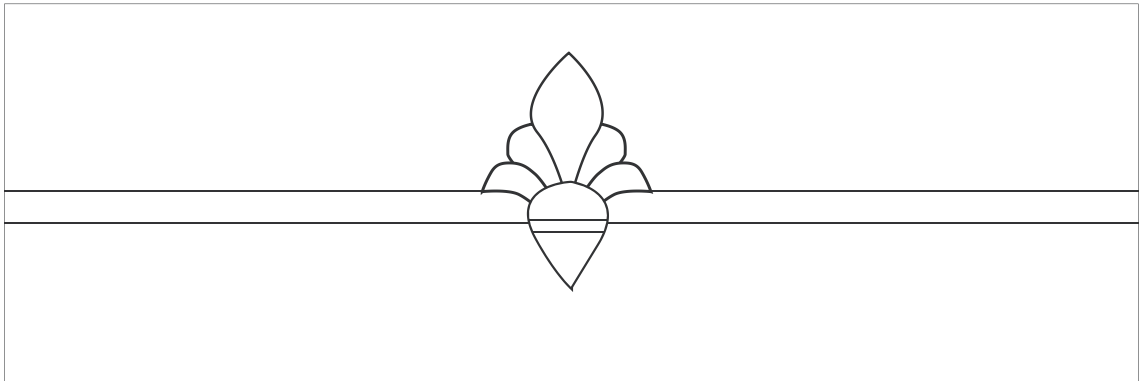

FGBC 6

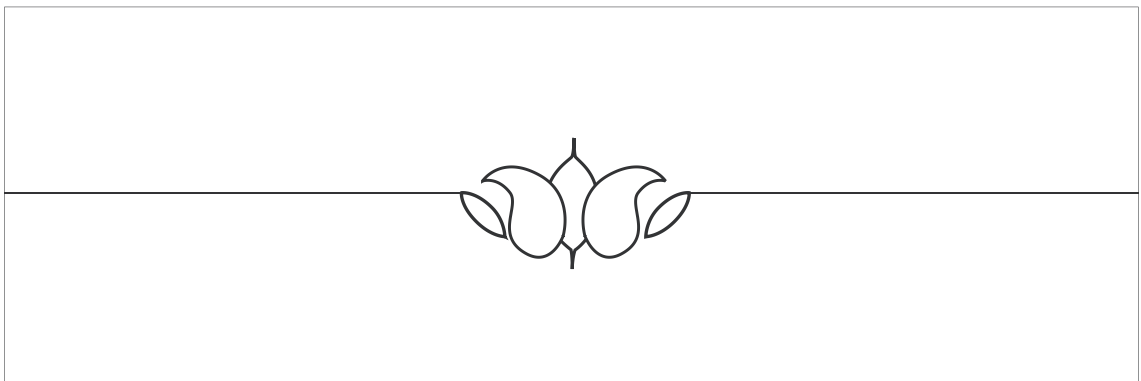

FGBC 7

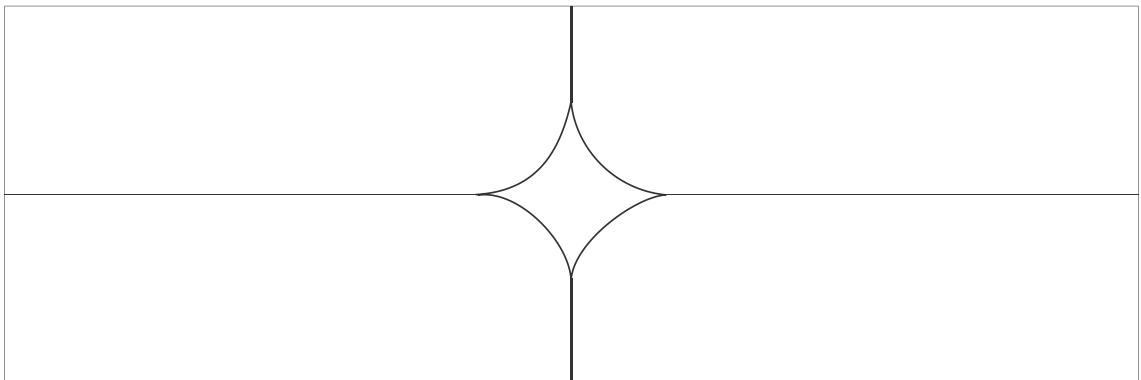

FGBC 8

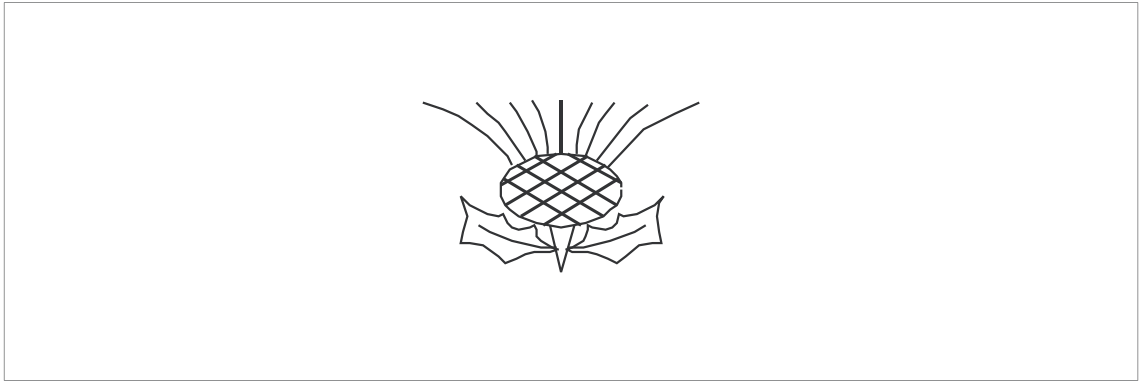

FGBC 9

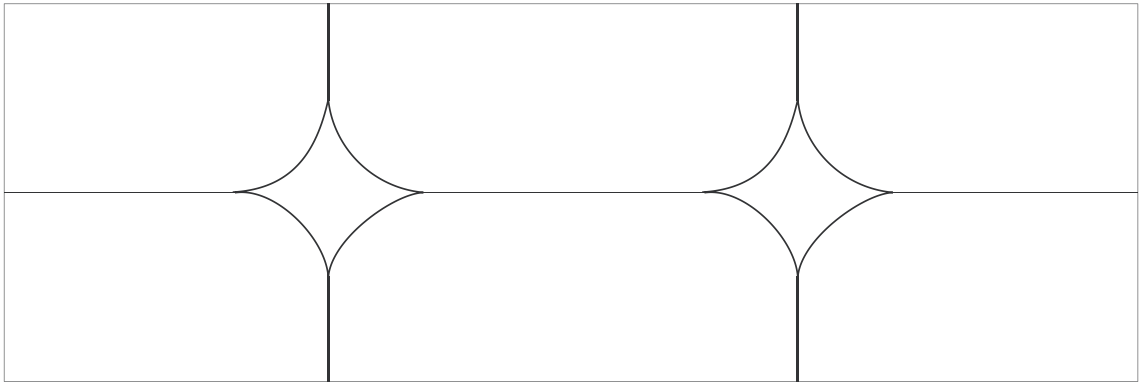

FGBC 10

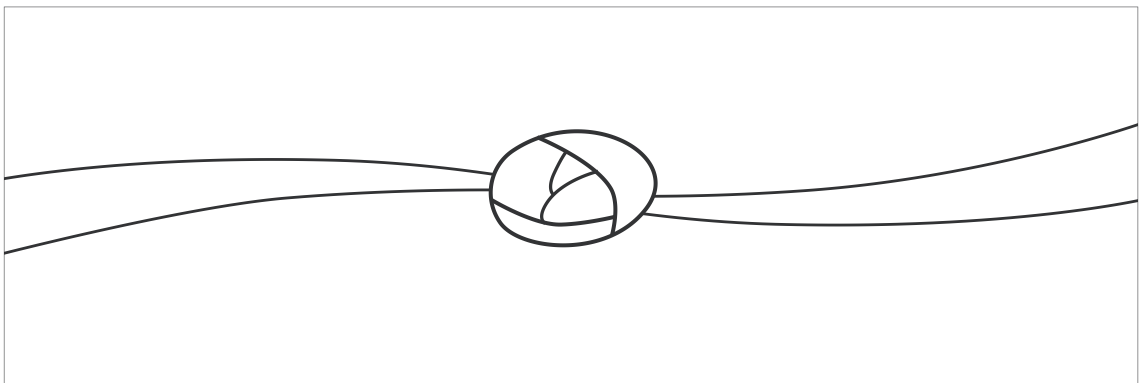

FGBC 11

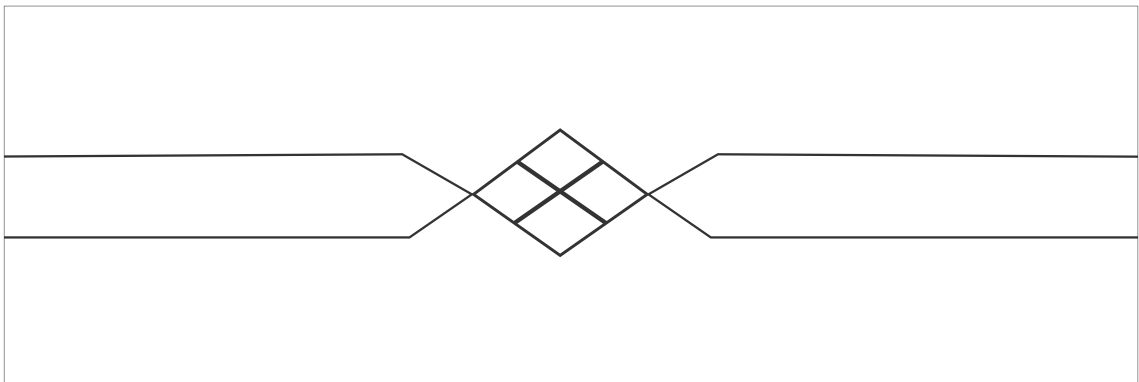

FGBC 12

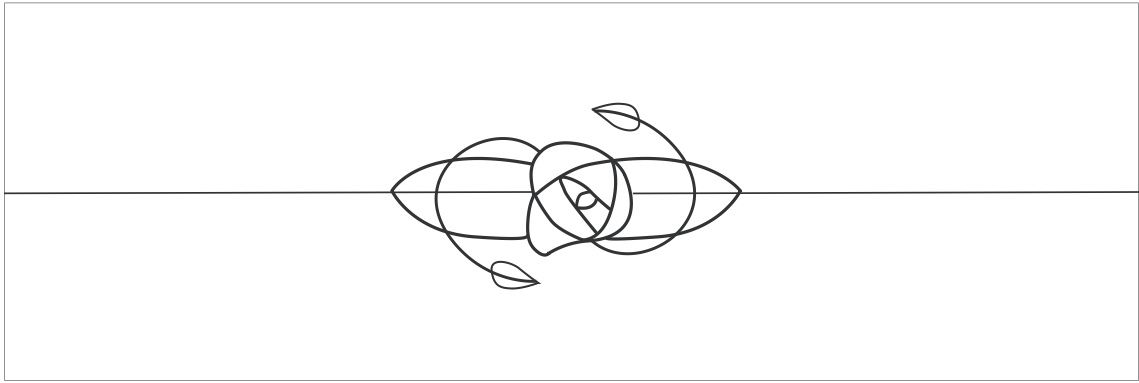

FGBC 13

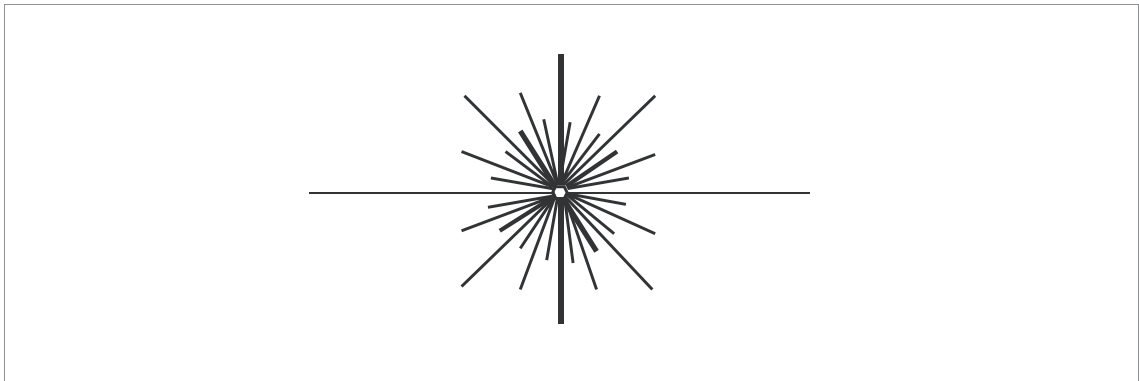

FGBC 15

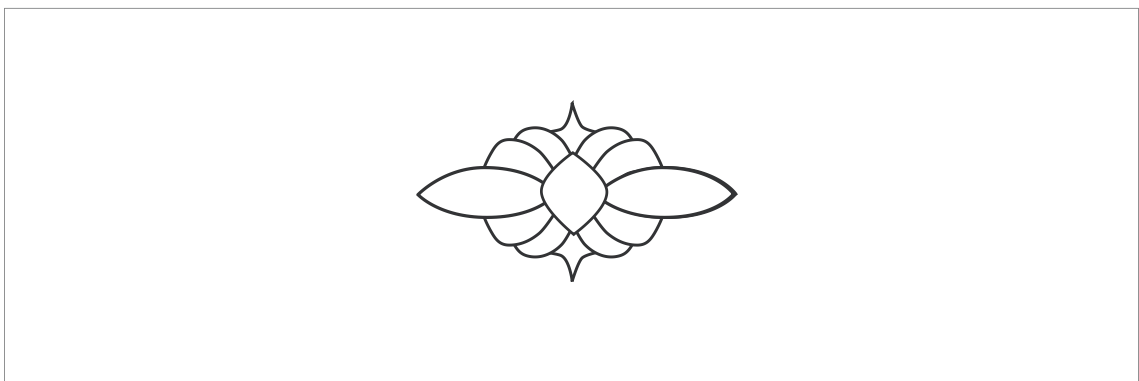

FGBC 16

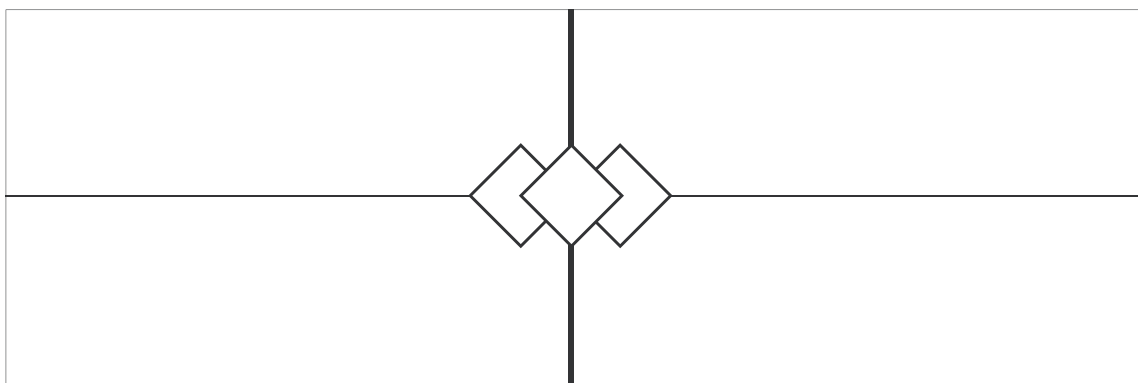

FGBC 17

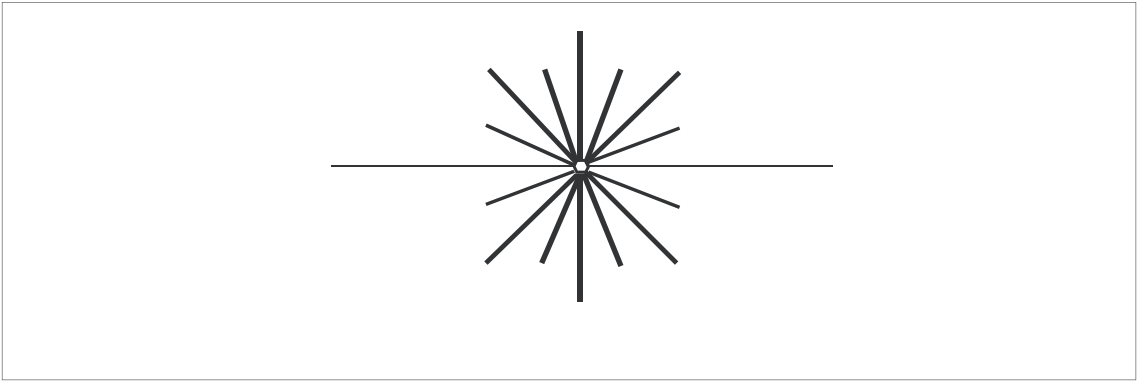

FGBC 18

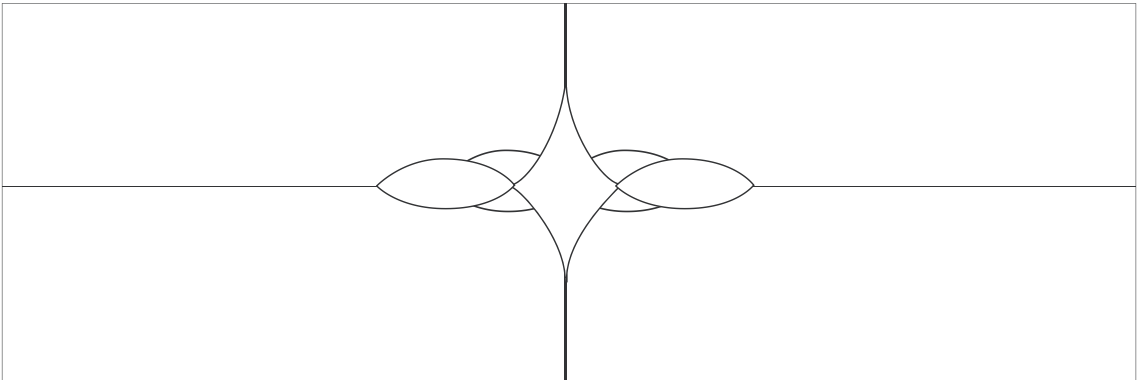

FGBC 19

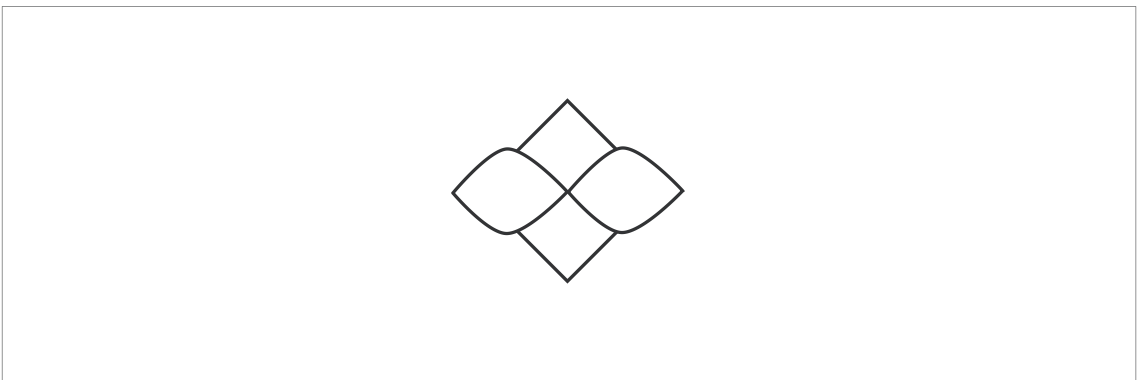

FGBC 20

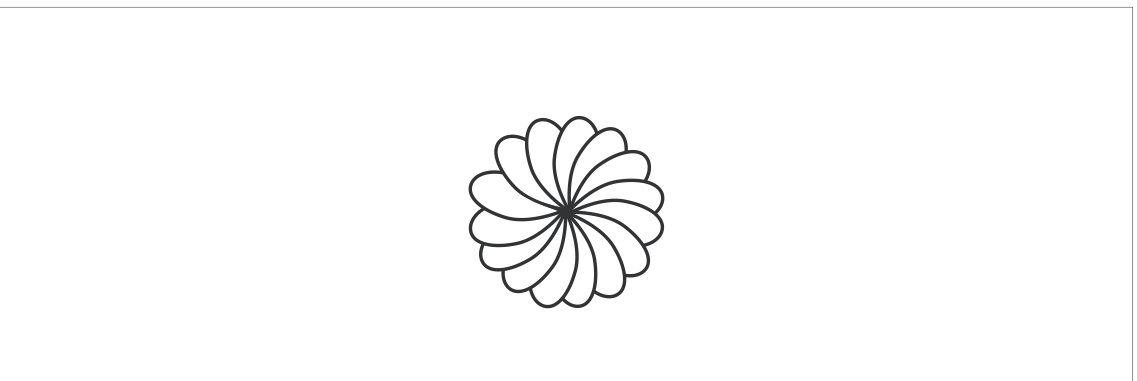

FGBC 21

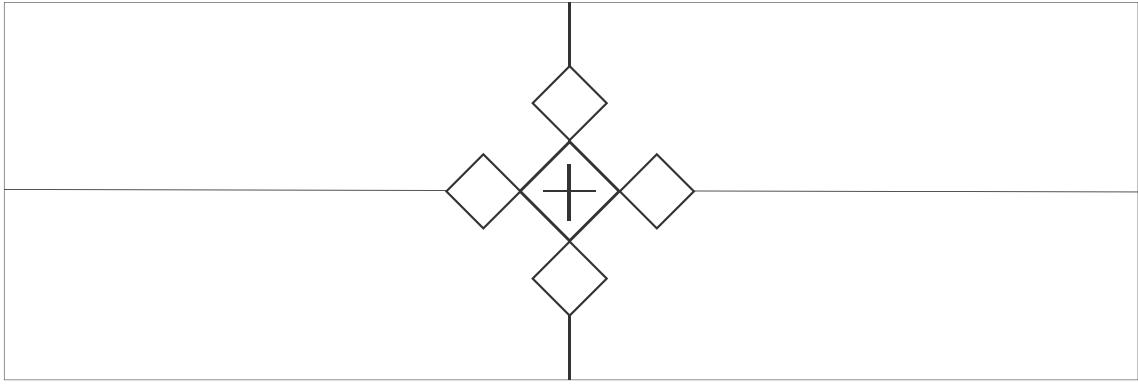

FGBC 22

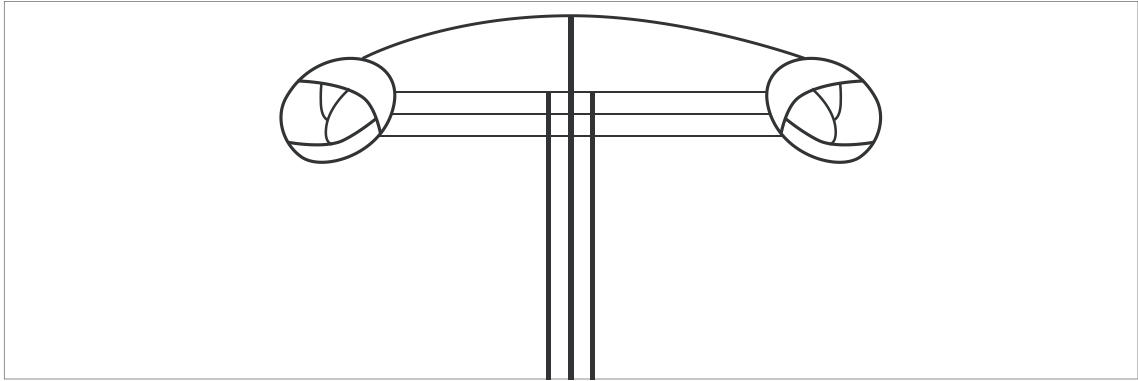

FGBC 23

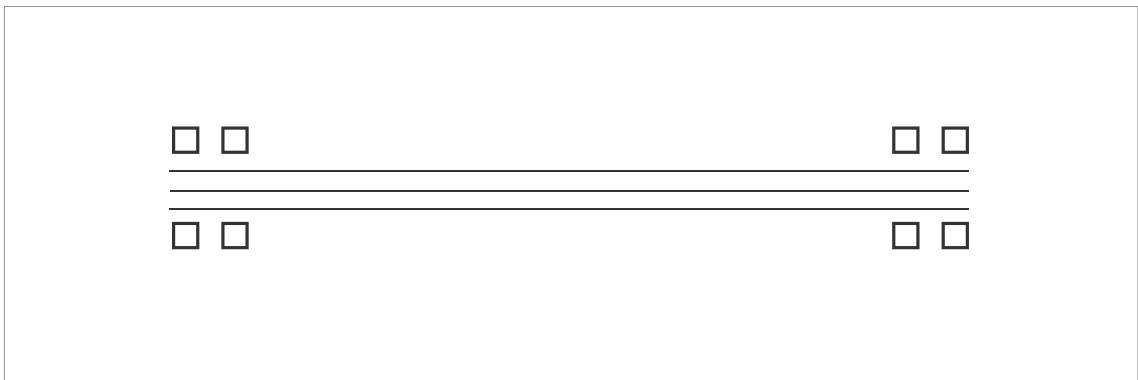

FGBC 24

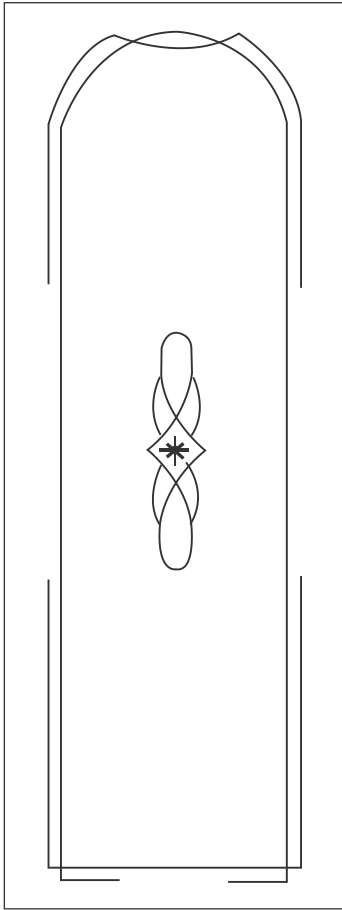

FGBC 101

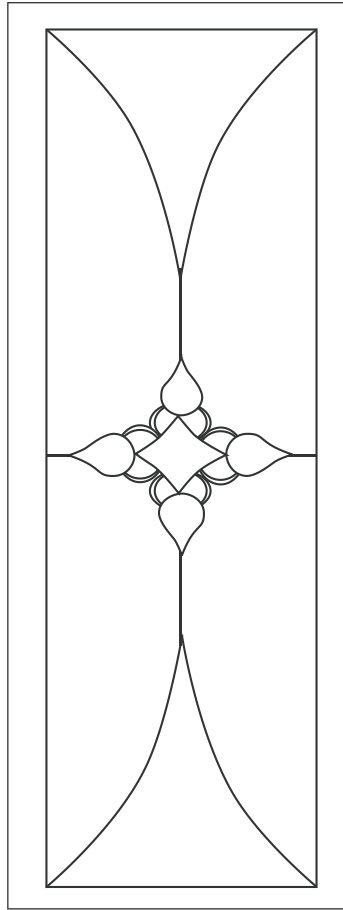

FGBC 102

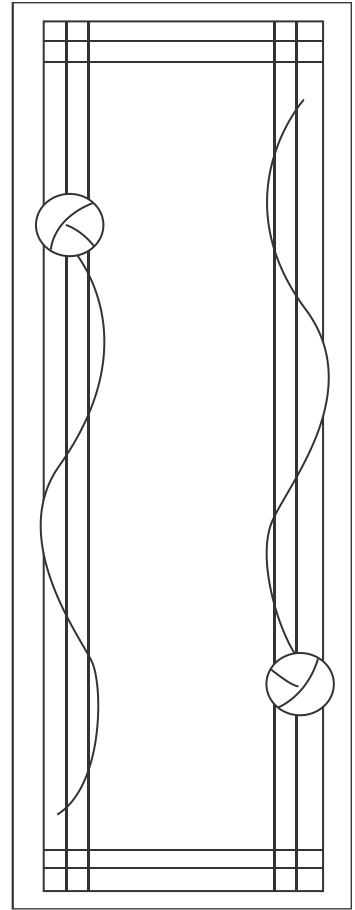

FGBC 103

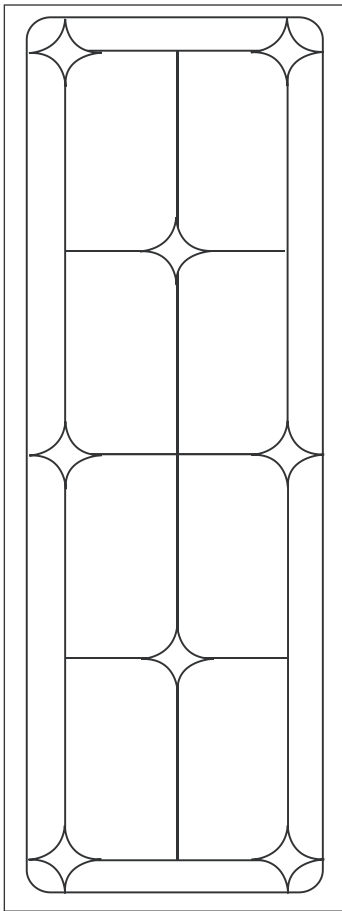

FGBC 104

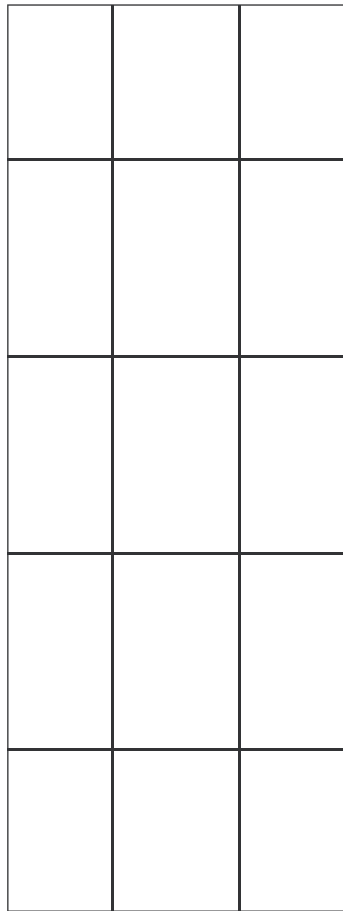

FGBC 105a

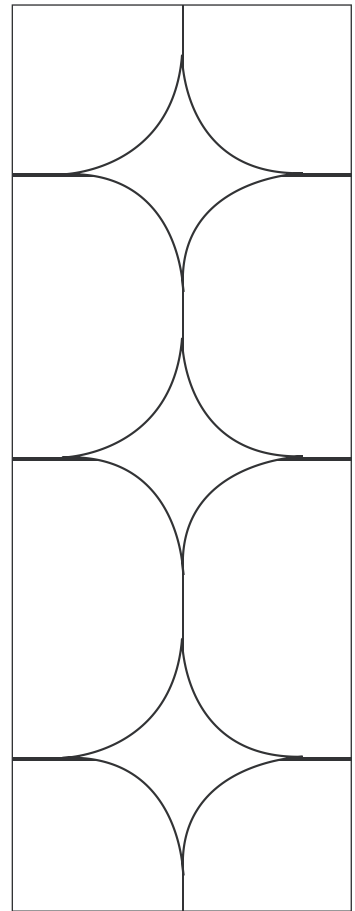

FGBC 106



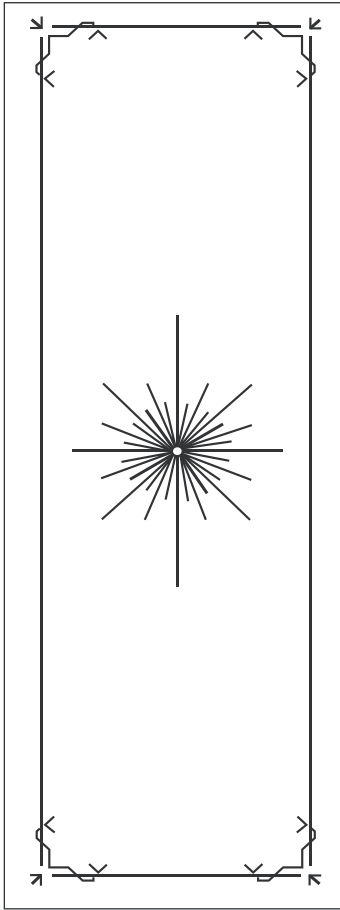

FGBC 107

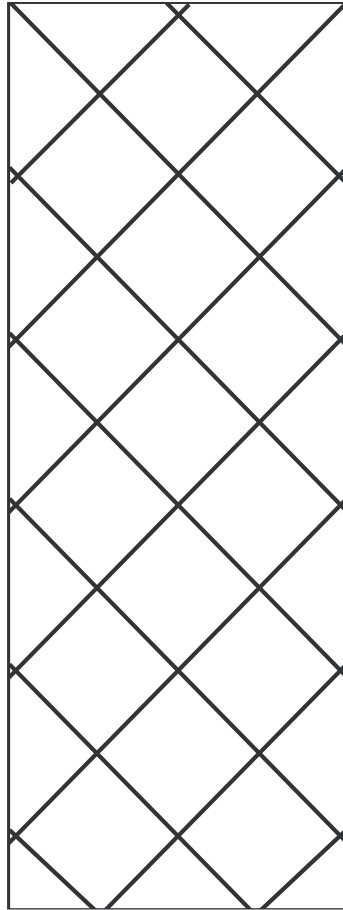

FGBC 108

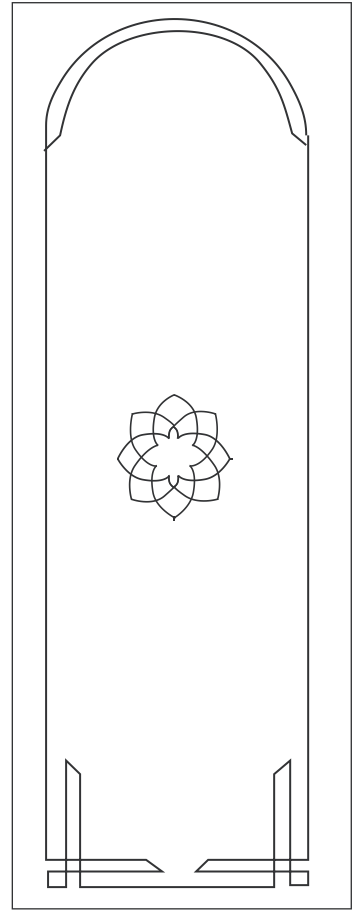

FGBC 109

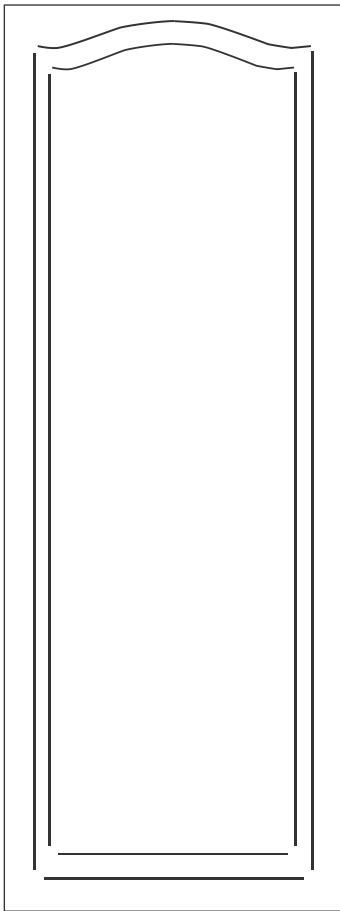

FGBC 110

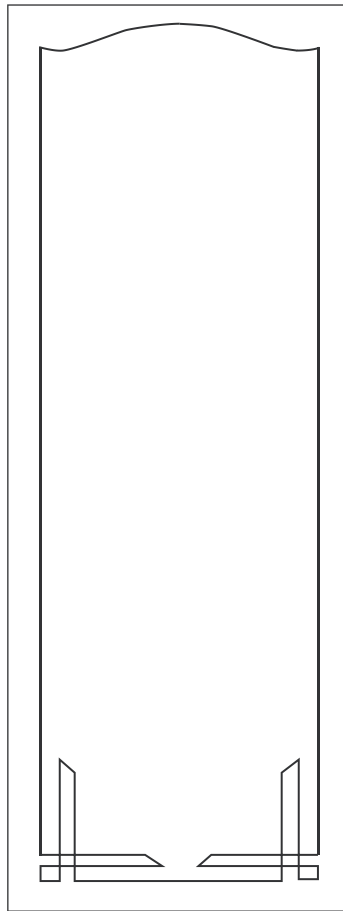

FGBC 111a

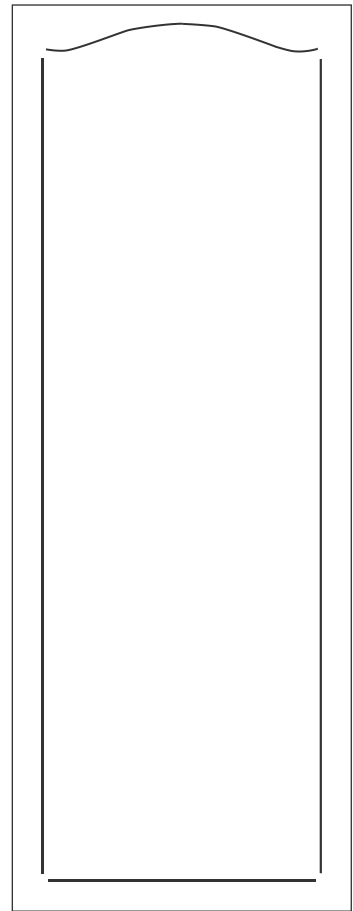

FGBC 112a

BRILLIANT CUT, BEVELLED & POLISHED GLASS  
MIRRORS • PICTURE FRAMES • HARDWOOD DOORS

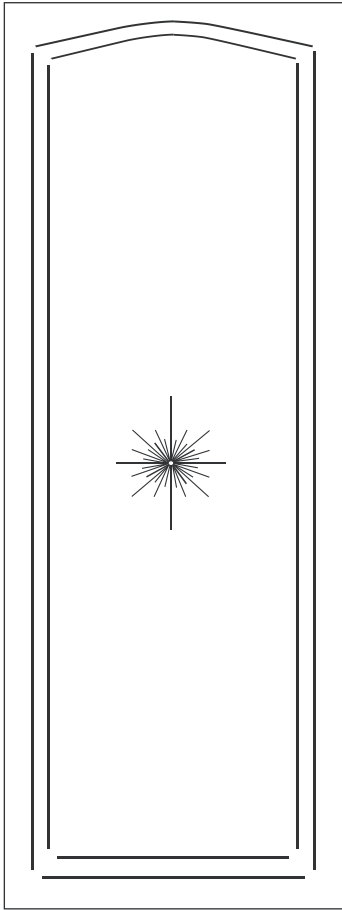

FGBC 113

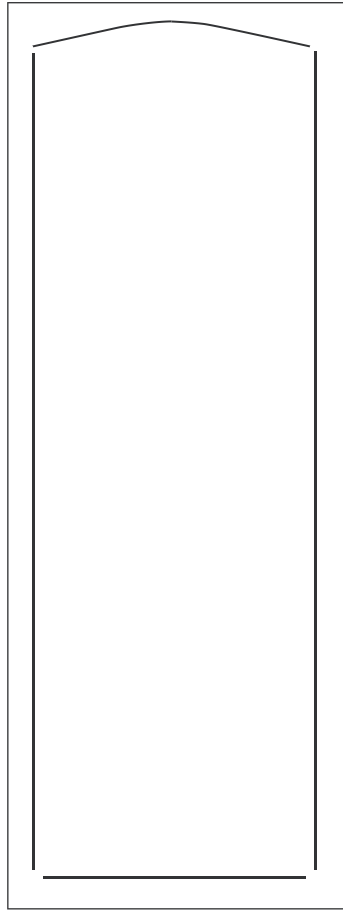

FGBC 114

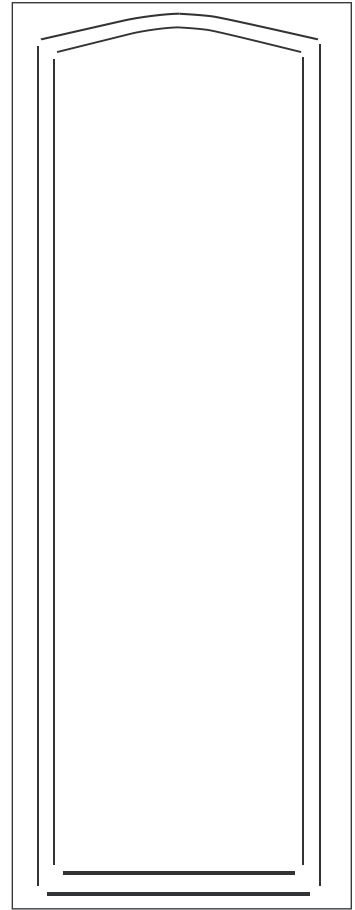

FGBC 115

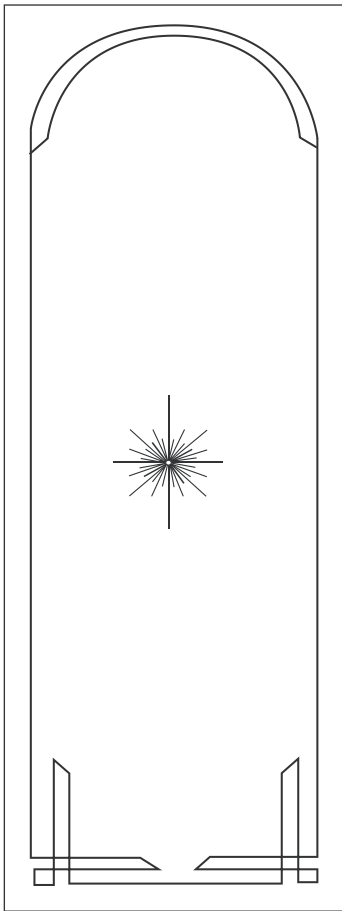

FGBC 116

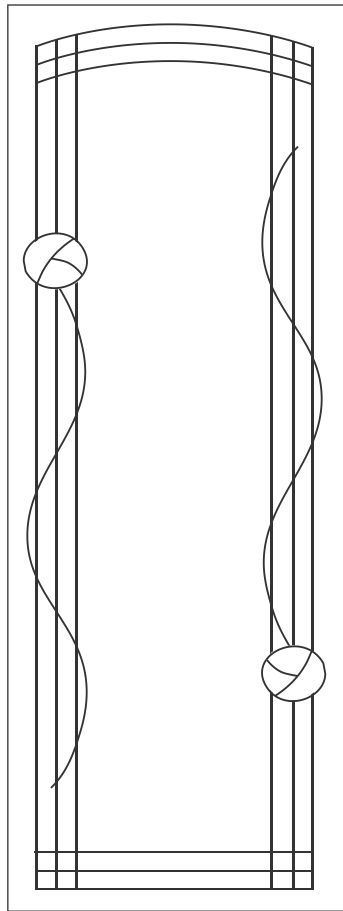

FGBC 117

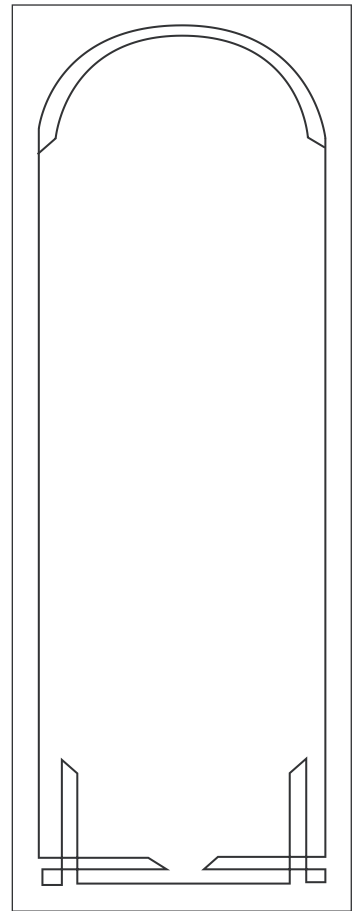

FGBC 118

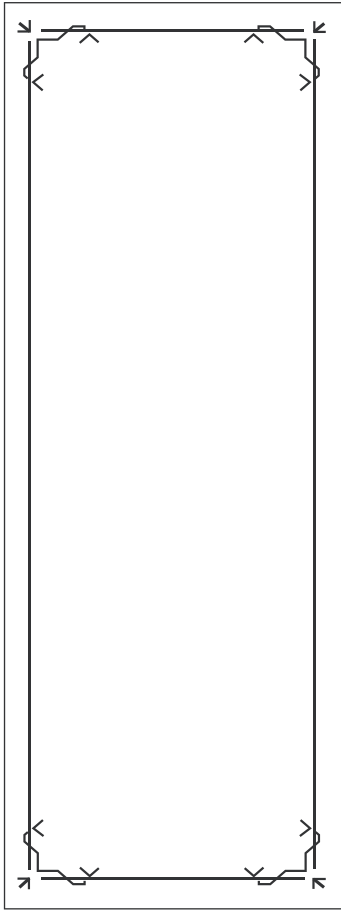

FGBC 119

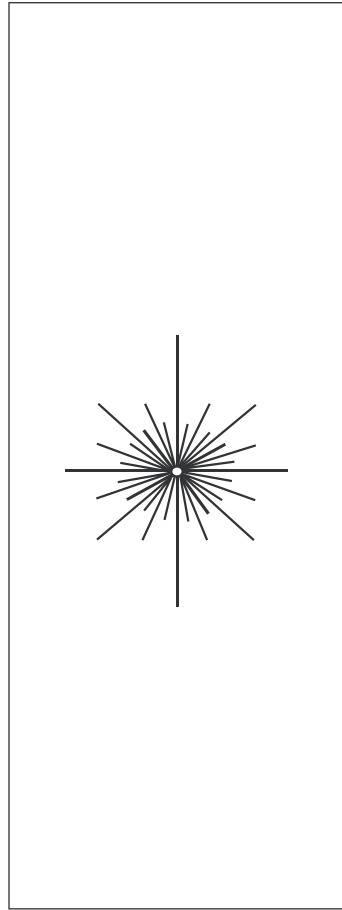

FGBC 120

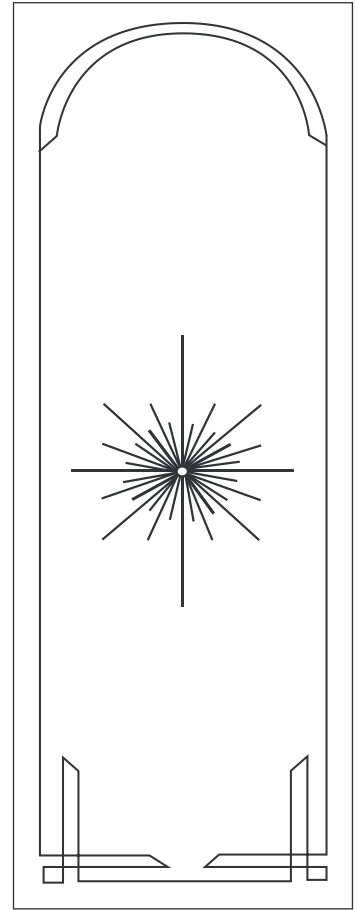

FGBC 121

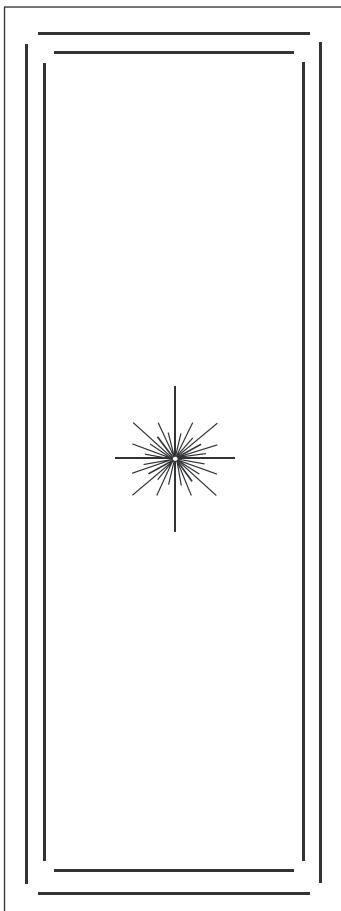

FGBC 122

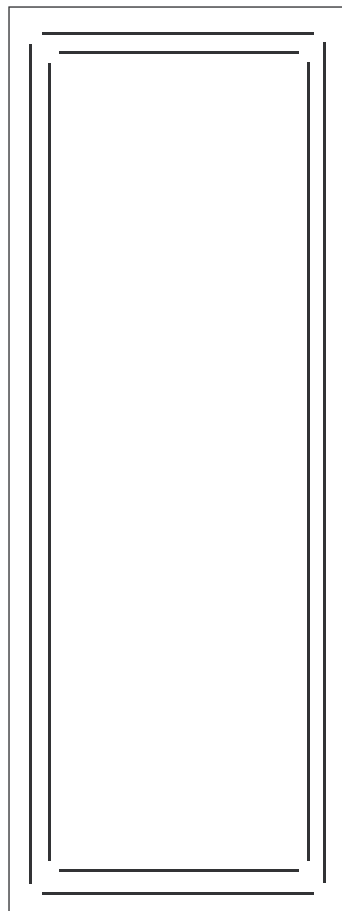

FGBC 123

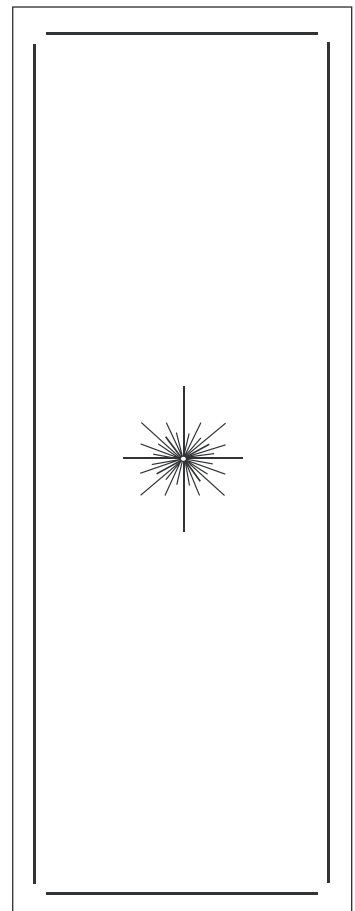

FGBC 124

BRILLIANT CUT, BEVELLED & POLISHED GLASS  
MIRRORS • PICTURE FRAMES • HARDWOOD DOORS

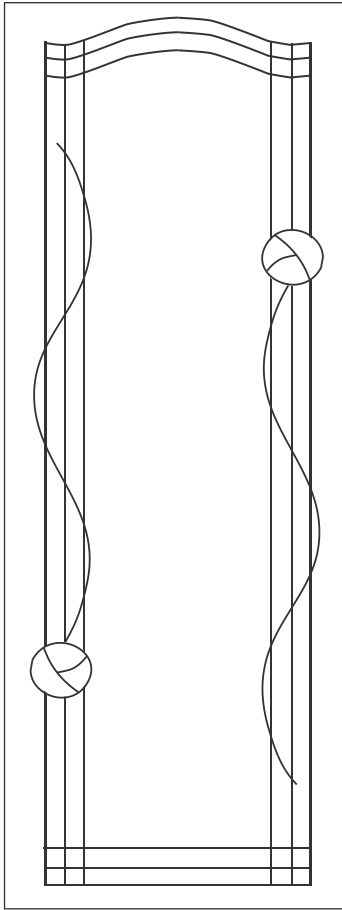

FGBC 125

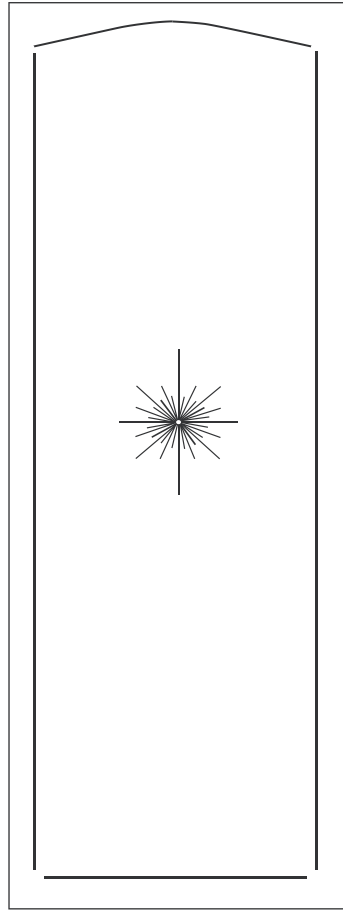

FGBC 126

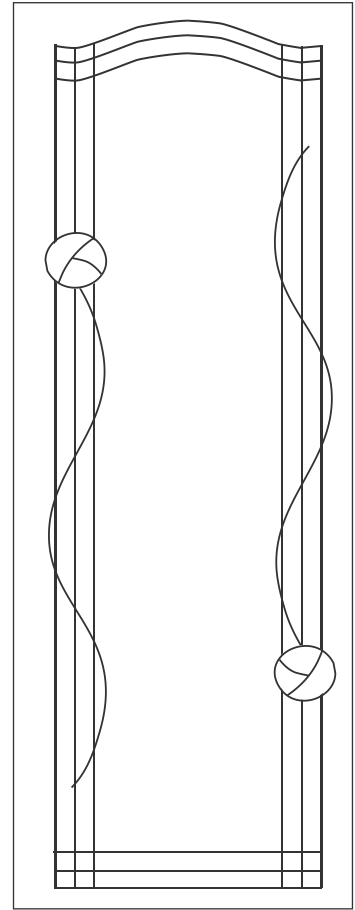

FGBC 127

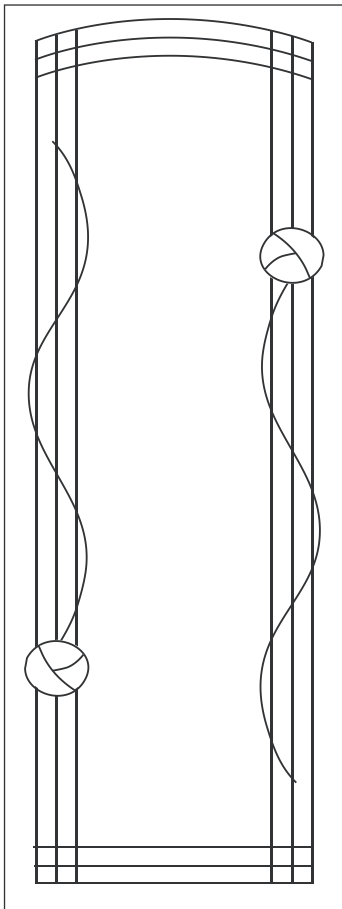

FGBC 128

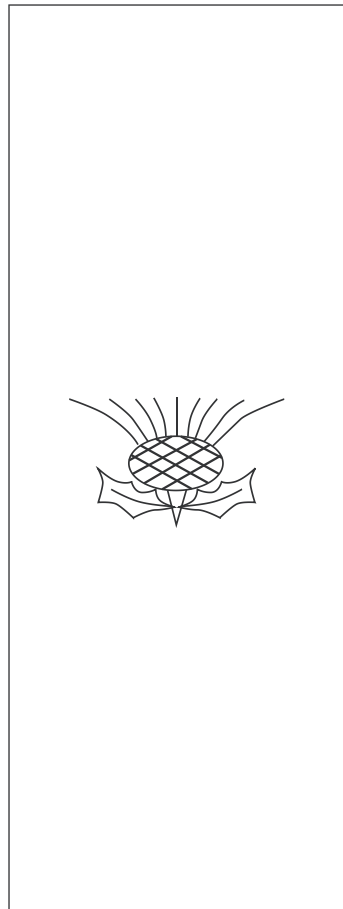

FGBC 129

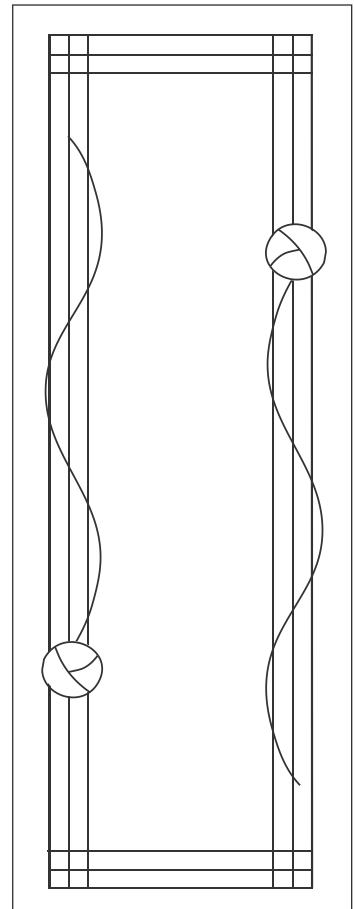

FGBC 130

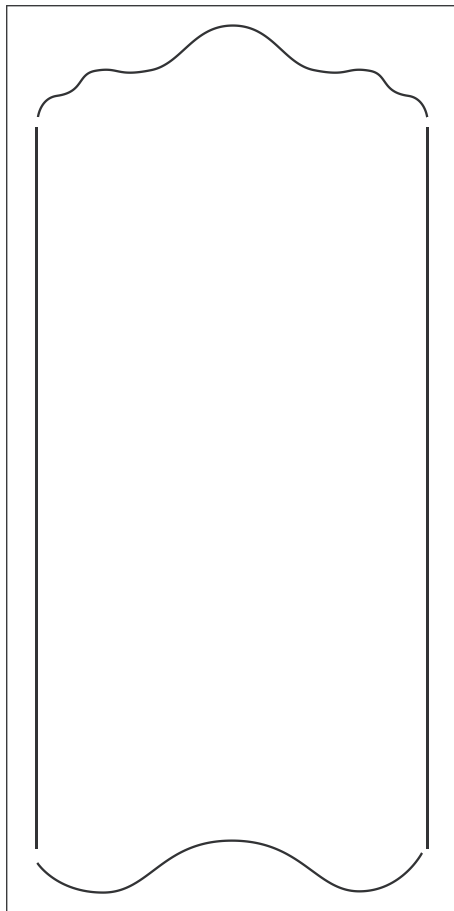

FGBC 131a

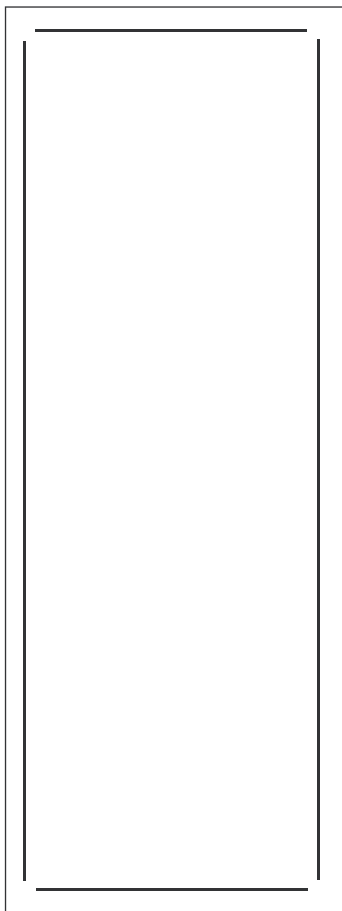

FGBC 132

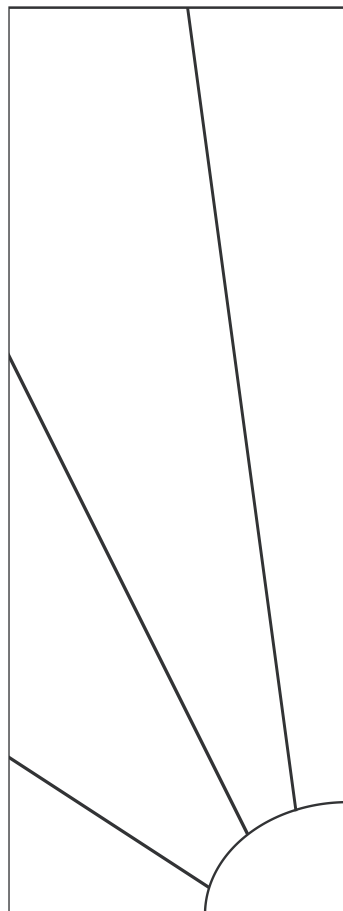

FGBC 133

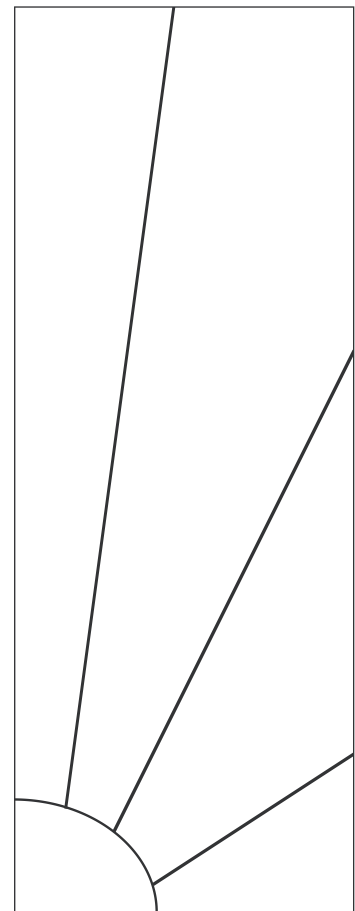

FGBC 134

BRILLIANT CUT, BEVELLED & POLISHED GLASS  
MIRRORS • PICTURE FRAMES • HARDWOOD DOORS

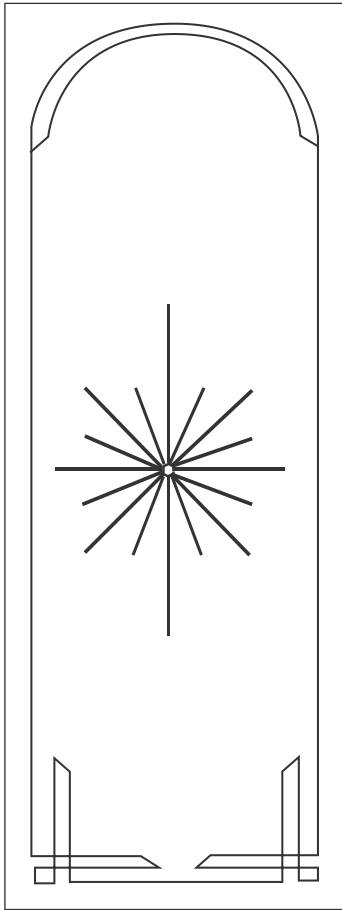

FGBC 135

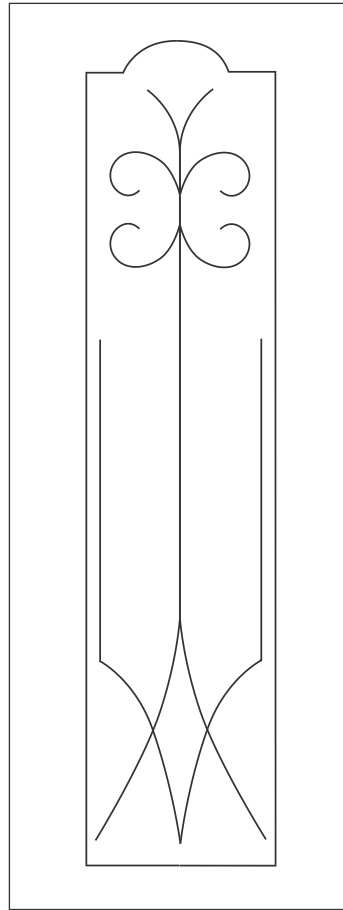

FGBC 136

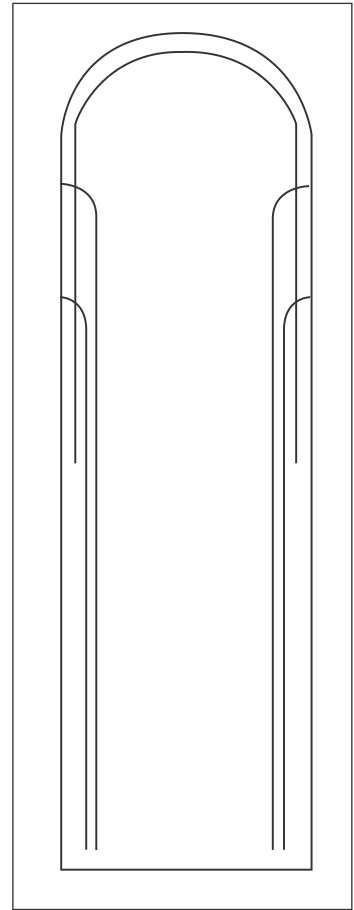

FGBC 137

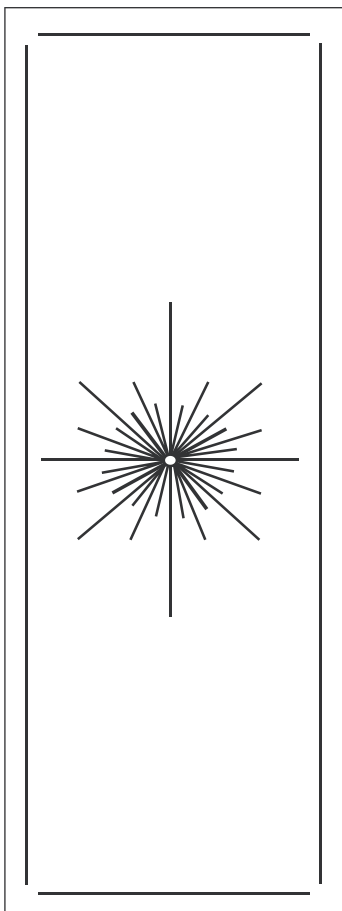

FGBC 138

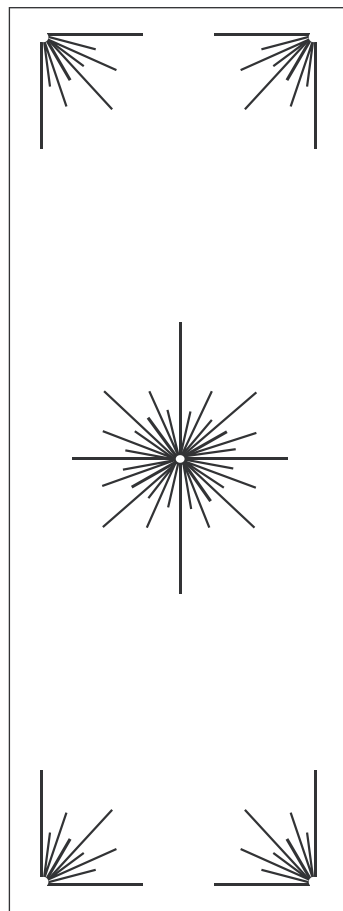

FGBC 139

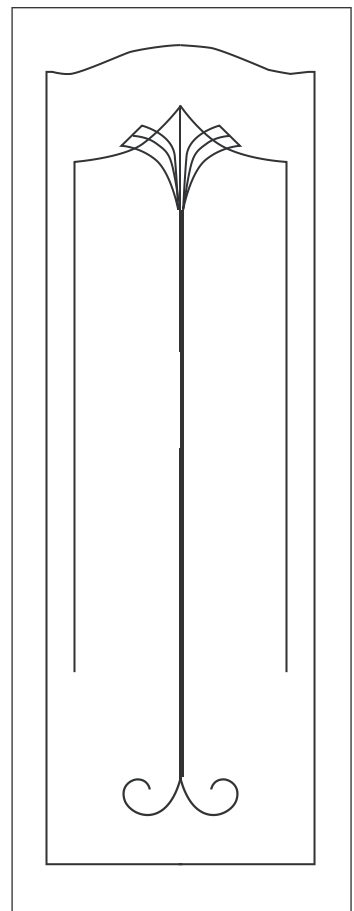

FGBC 140

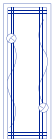

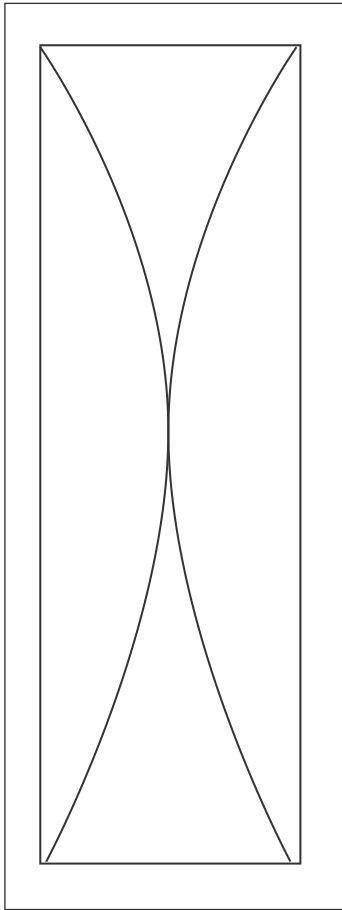

FGBC 141

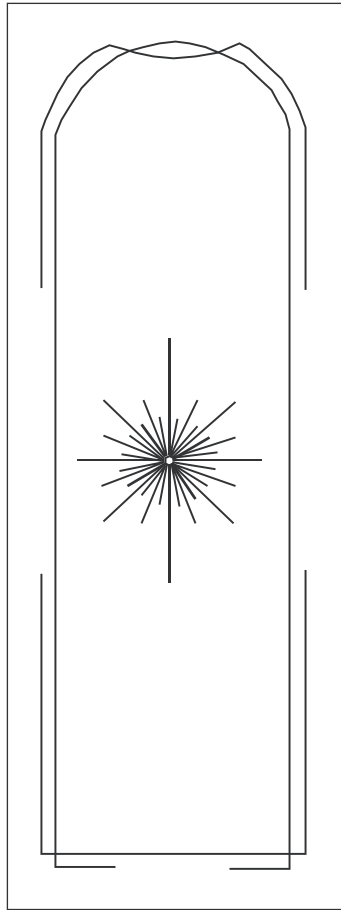

FGBC 142

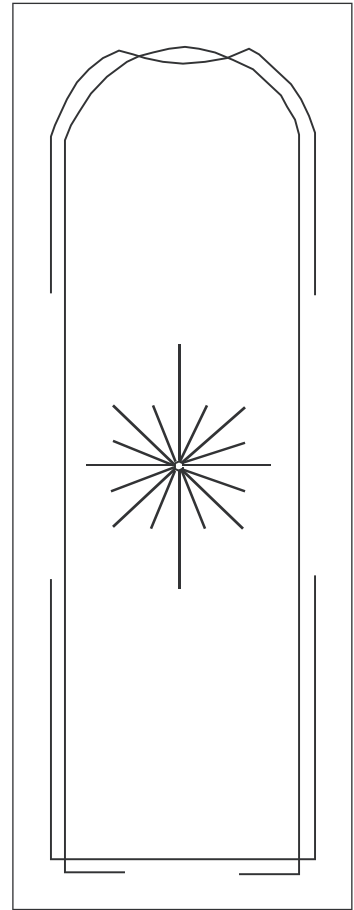

FGBC 143

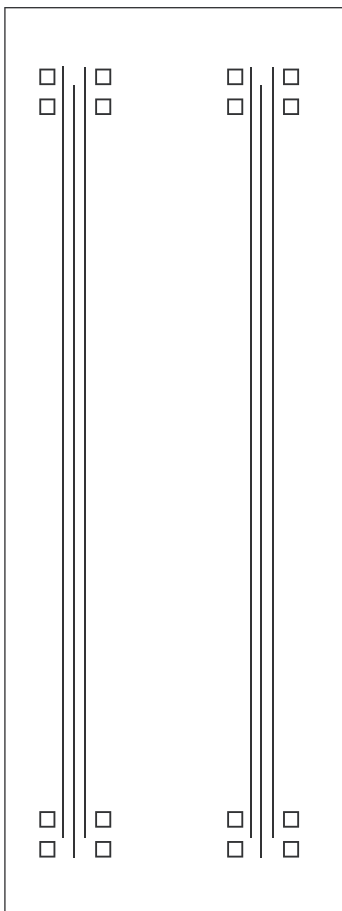

FGBC 144

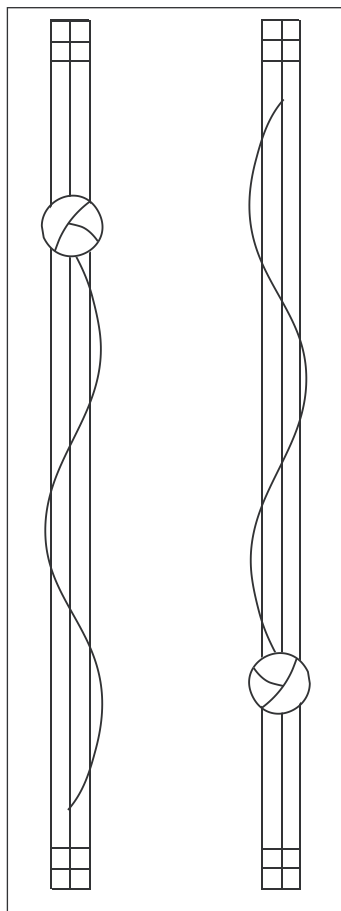

FGBC 145

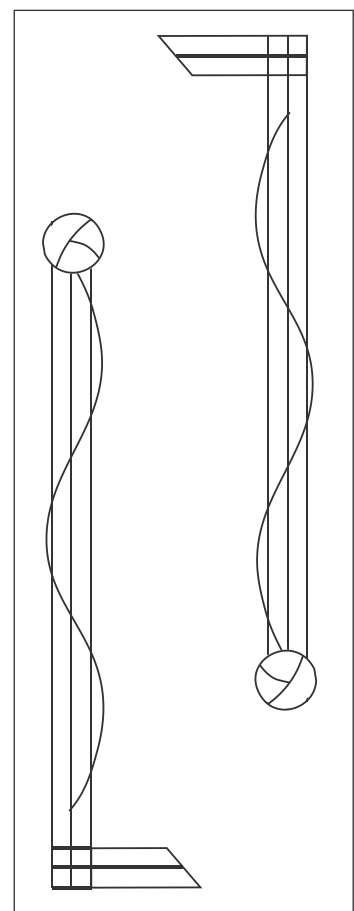

FGBC 146

BRILLIANT CUT, BEVELLED & POLISHED GLASS  
MIRRORS • PICTURE FRAMES • HARDWOOD DOORS

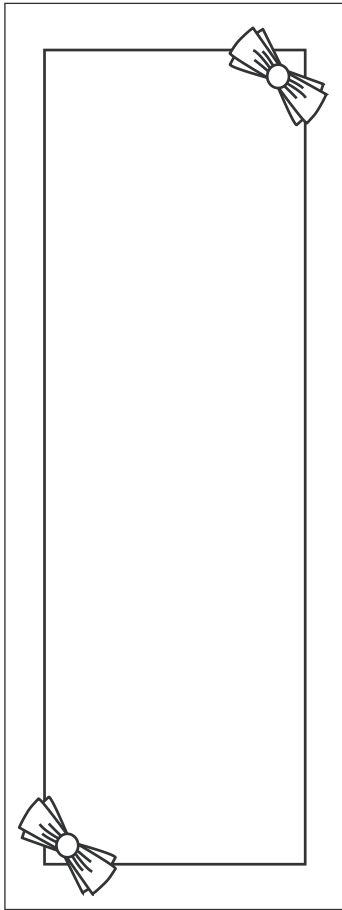

FGBC 149

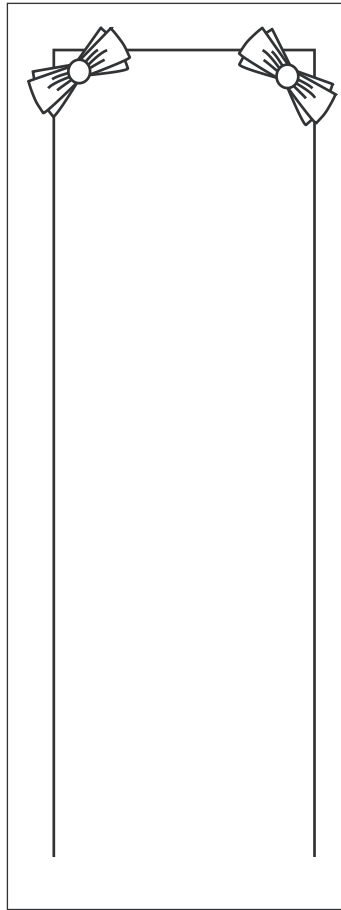

FGBC 150

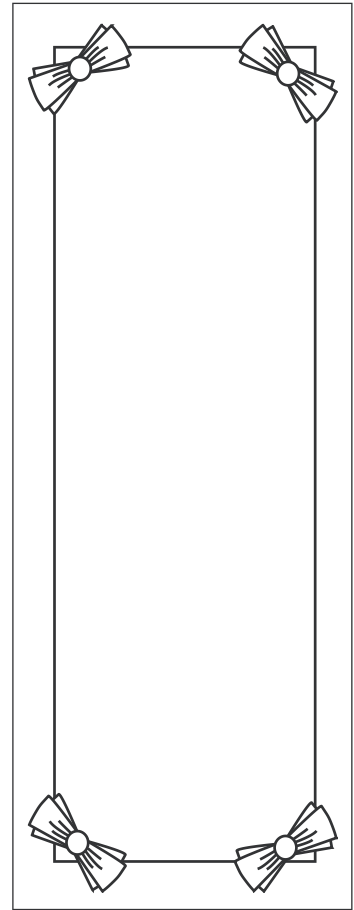

FGBC 151

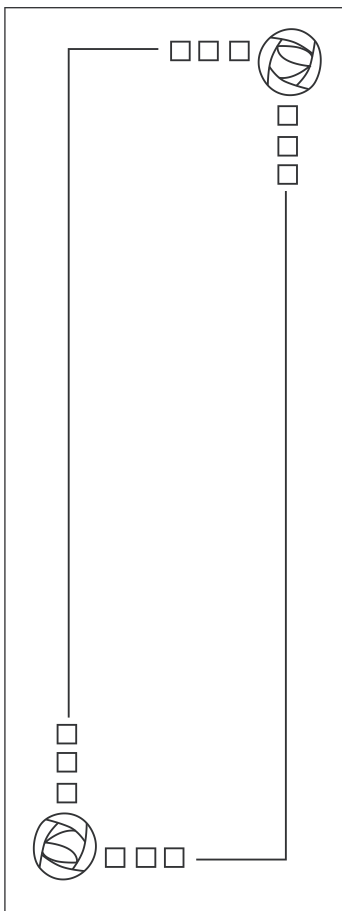

FGBC 152

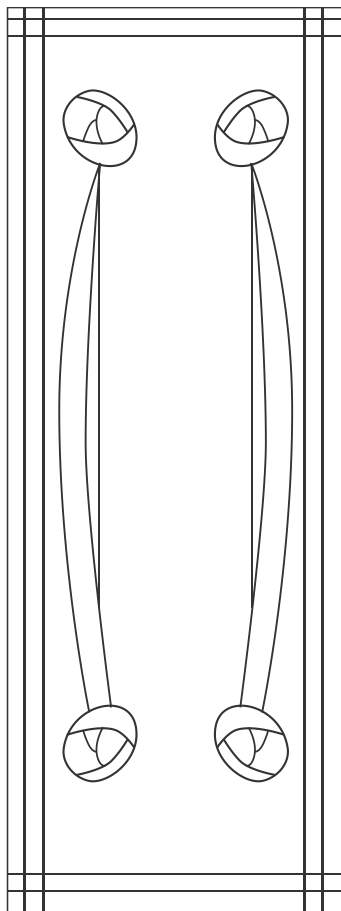

FGBC 153

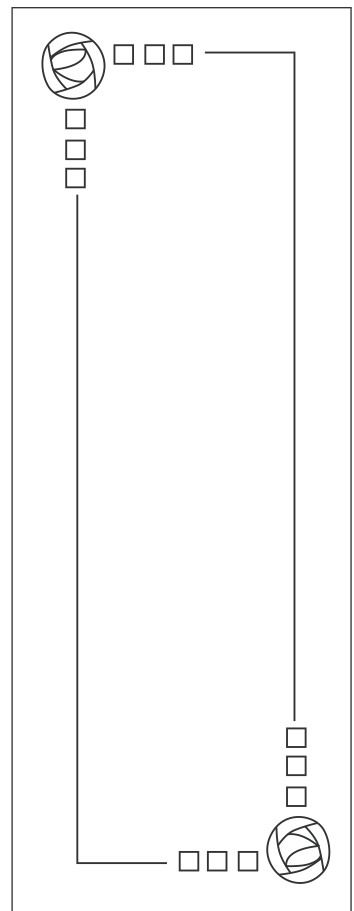

FGBC 154

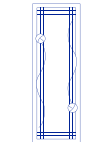



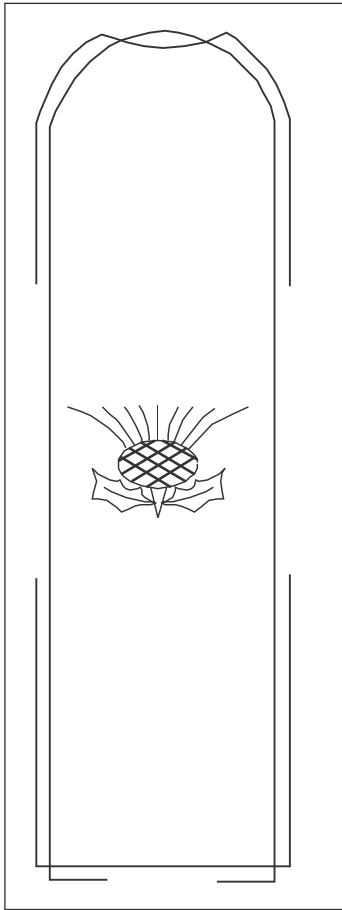

FGBC 155

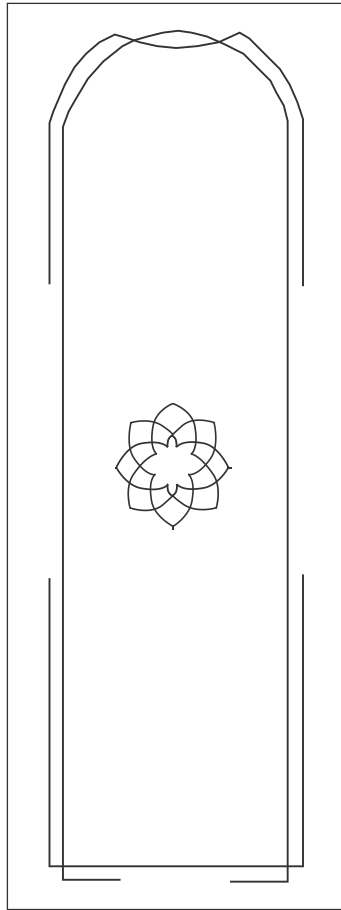

FGBC 156

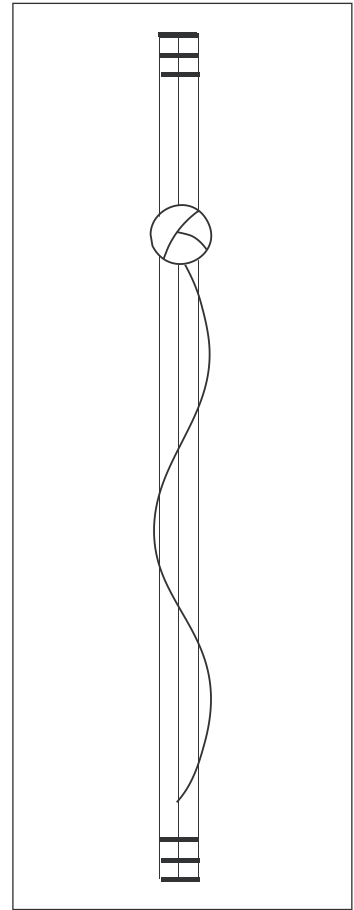

FGBC 157

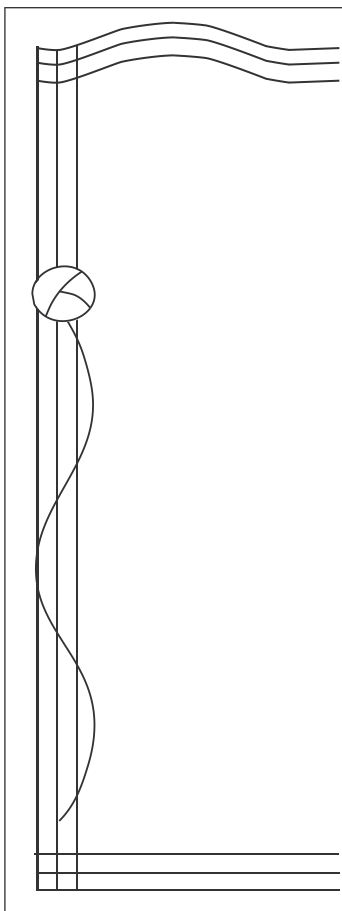

FGBC 158

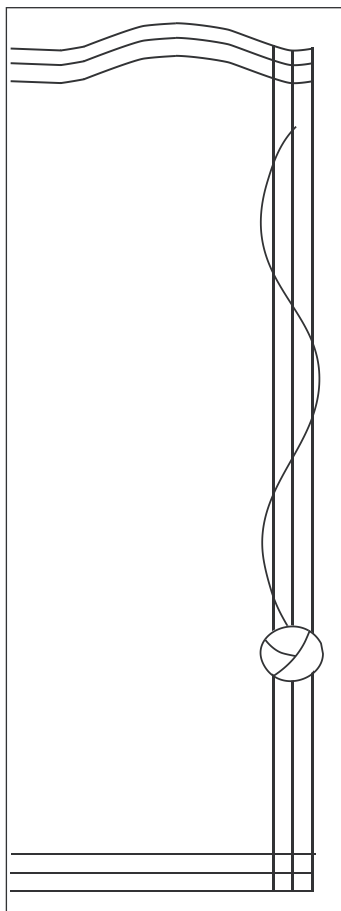

FGBC 159

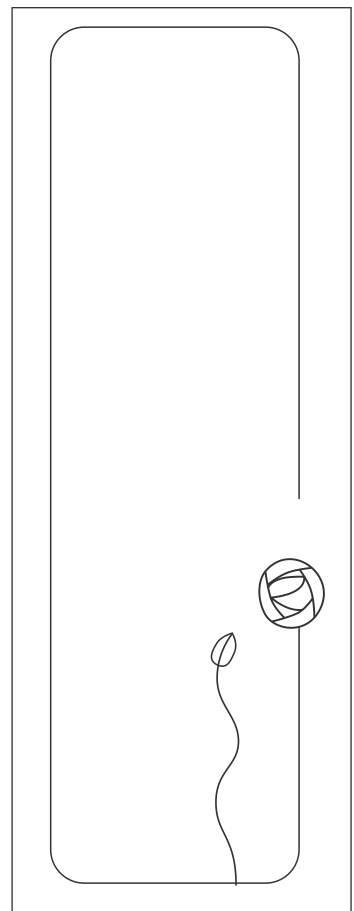

FGBC 160

BRILLIANT CUT, BEVELLED & POLISHED GLASS  
MIRRORS • PICTURE FRAMES • HARDWOOD DOORS

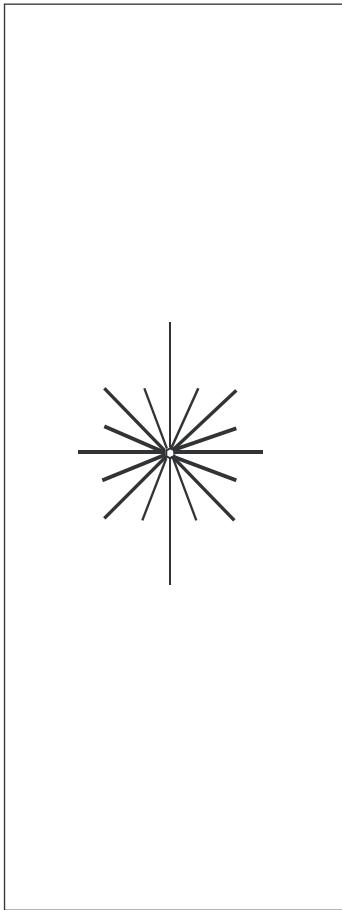

FGBC 161

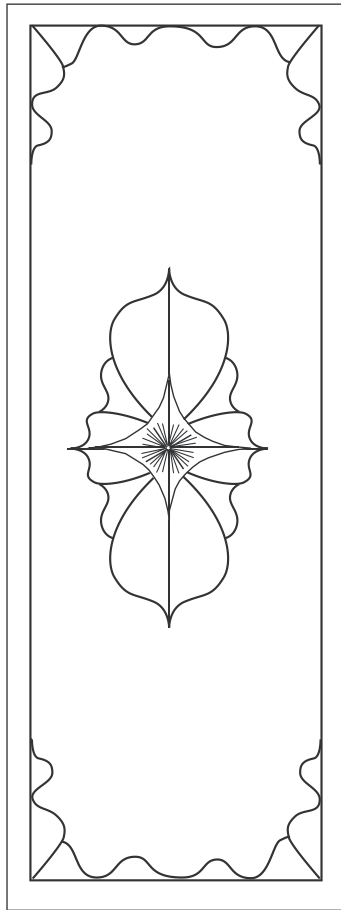

FGBC 162

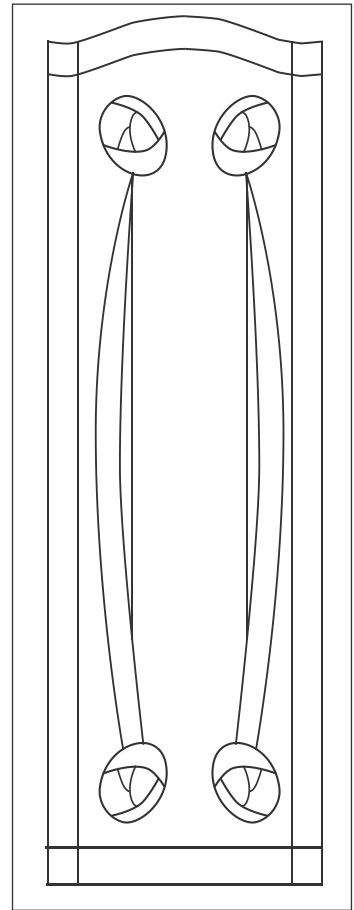

FGBC 163

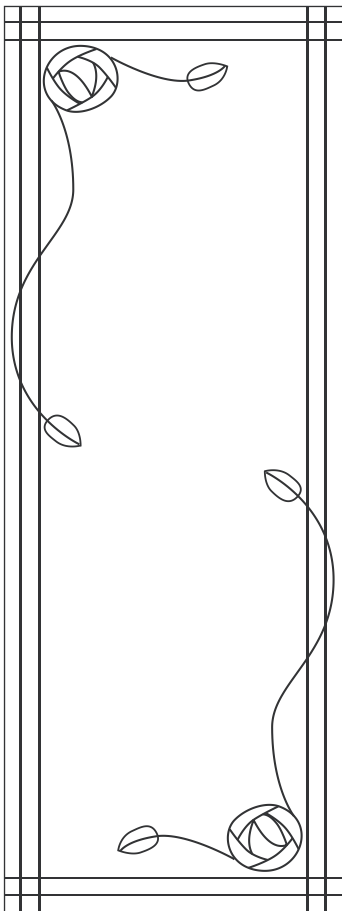

FGBC 164

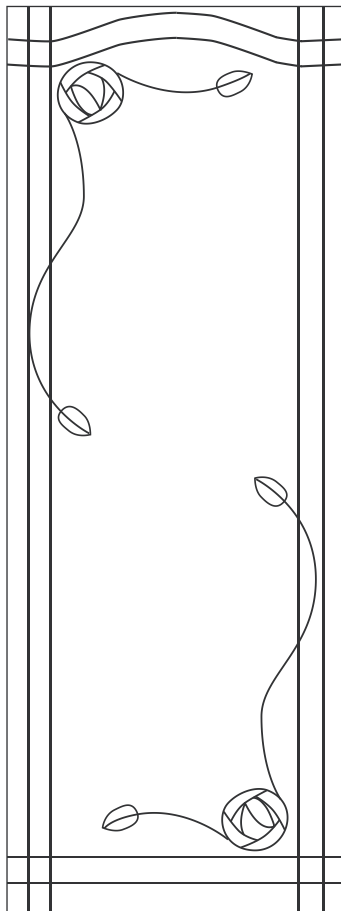

FGBC 165

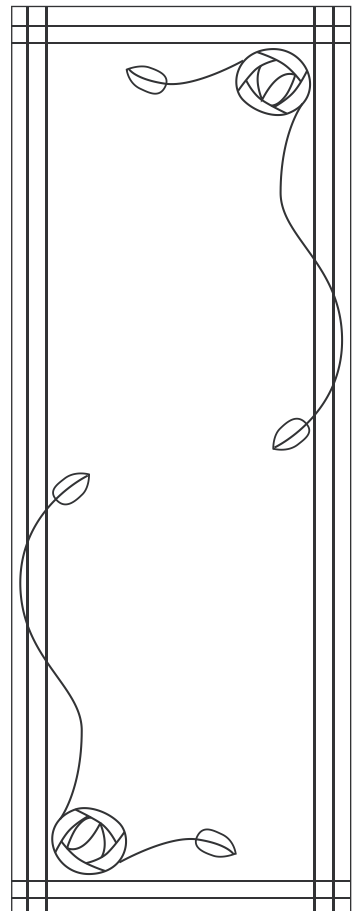

FGBC 166

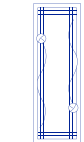

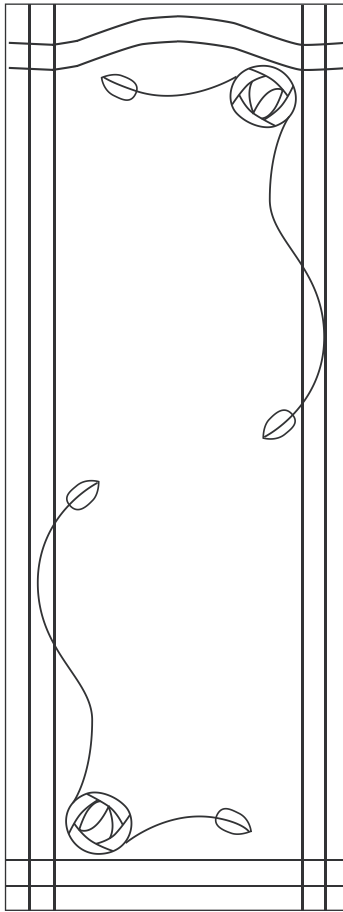

FGBC 167

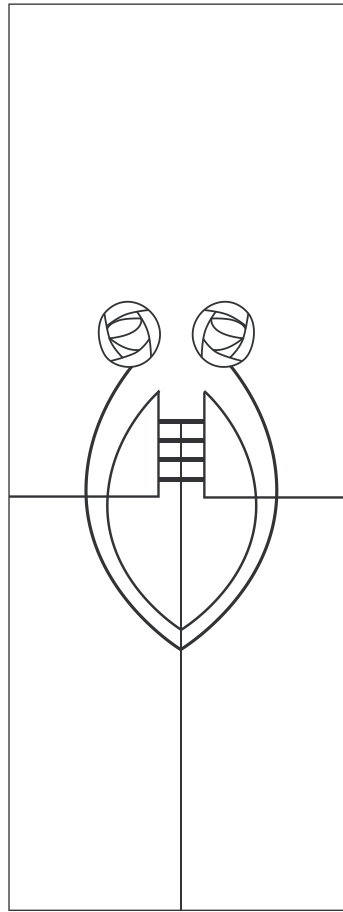

FGBC 168

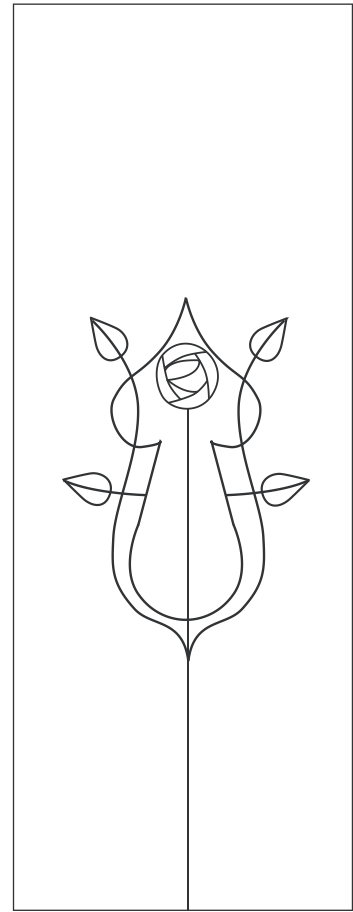

FGBC 169

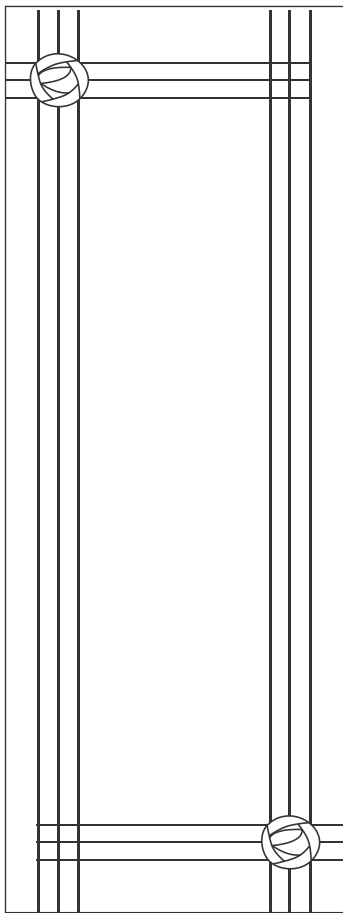

FGBC 171

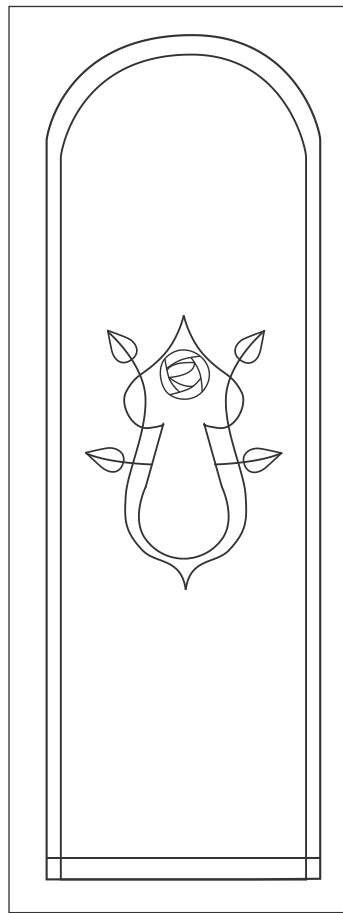

FGBC 172

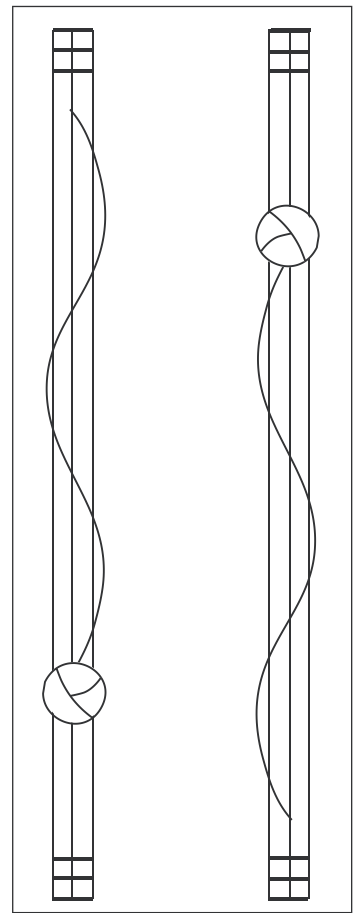

FGBC 173

BRILLIANT CUT, BEVELLED & POLISHED GLASS  
MIRRORS • PICTURE FRAMES • HARDWOOD DOORS

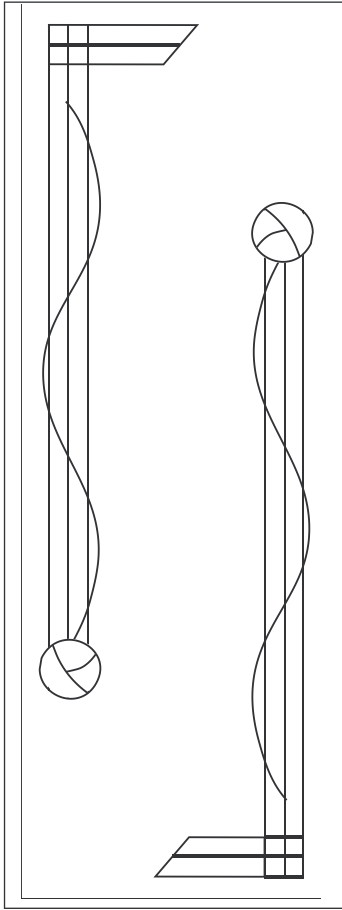

FGBC 174

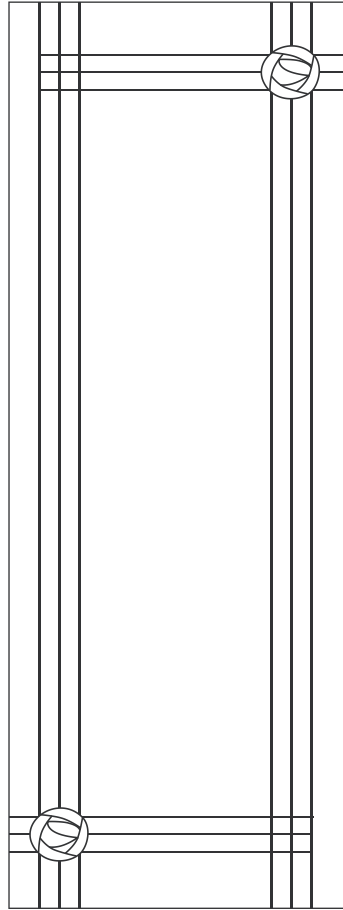

FGBC 175

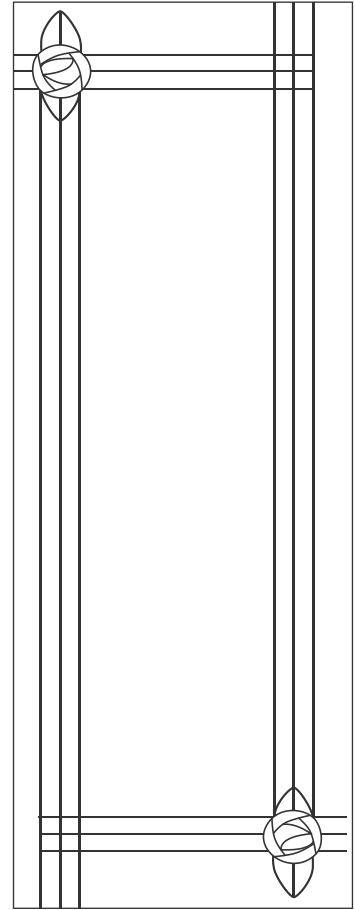

FGBC 176

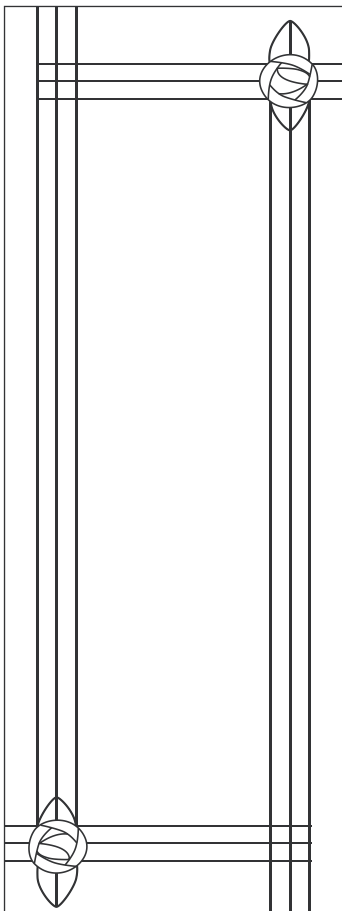

FGBC 177

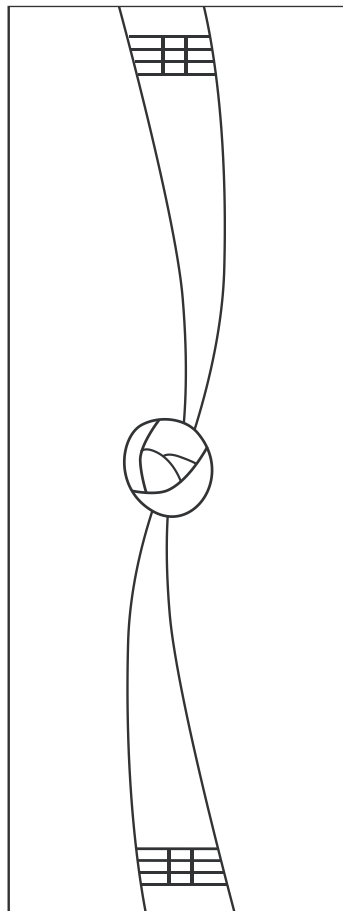

FGBC 178

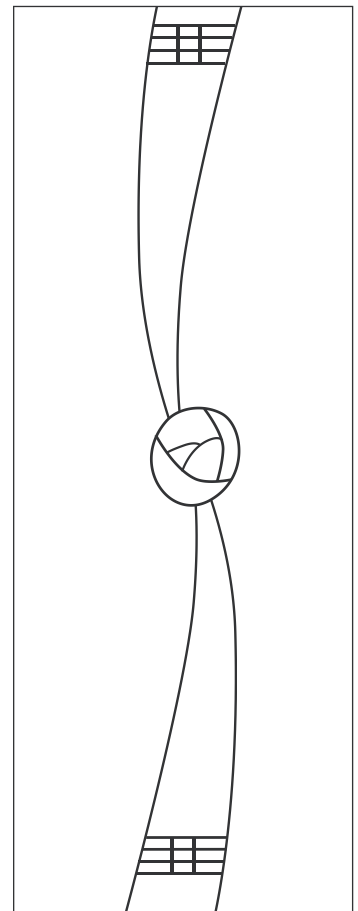

FGBC 179

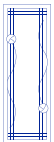

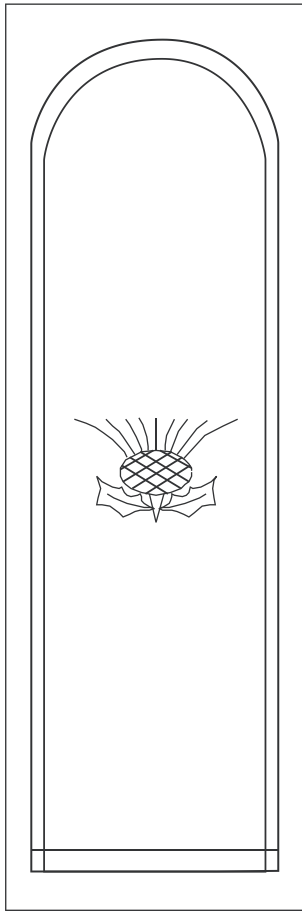

FGBC 180

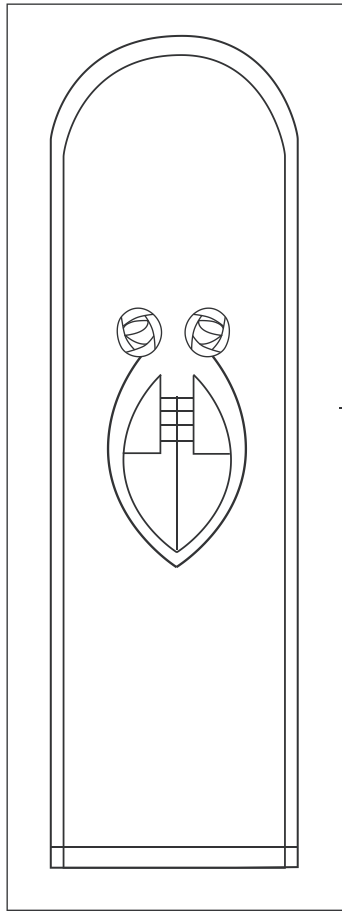

FGBC 181

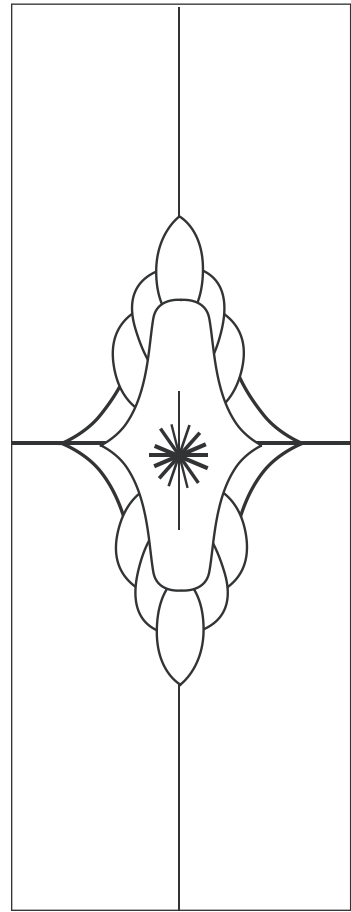

FGBC 182

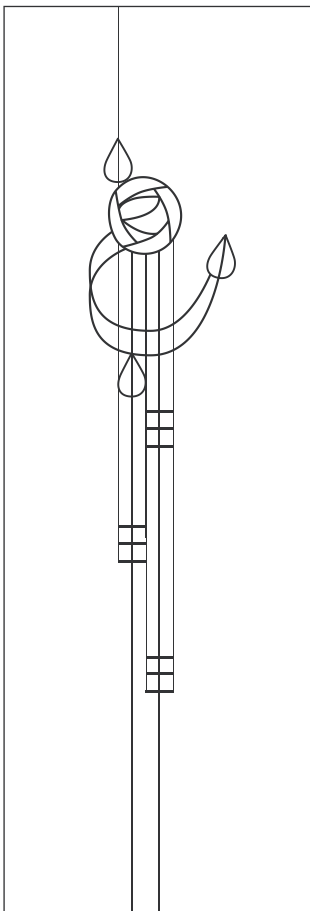

FGBC 183

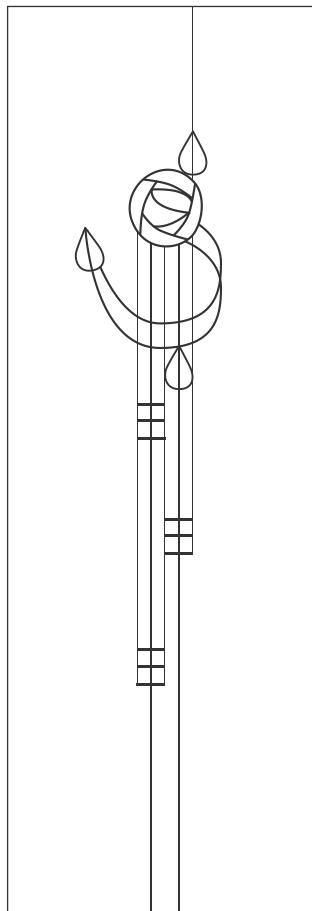

FGBC 184

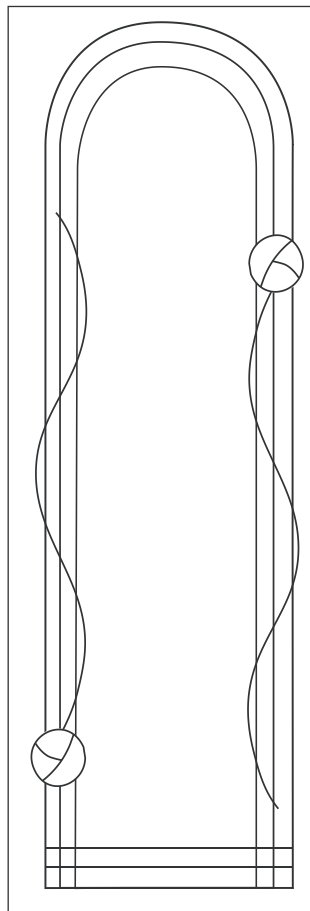

FGBC 404

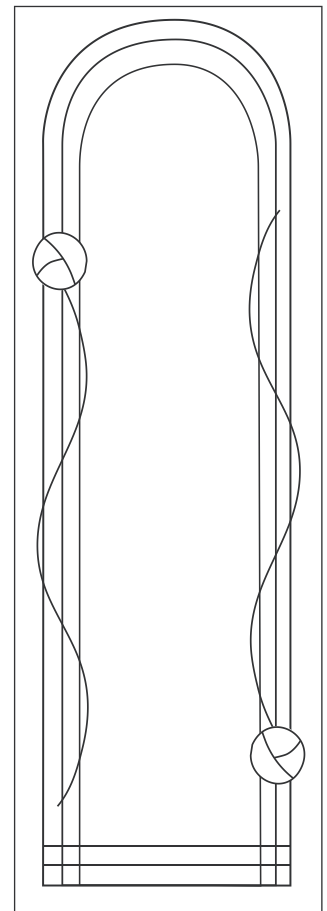

FGBC 412

BRILLIANT CUT, BEVELLED & POLISHED GLASS  
MIRRORS • PICTURE FRAMES • HARDWOOD DOORS

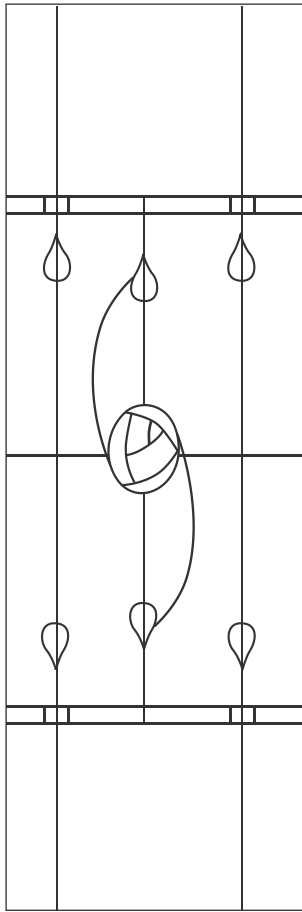

FGBC 185

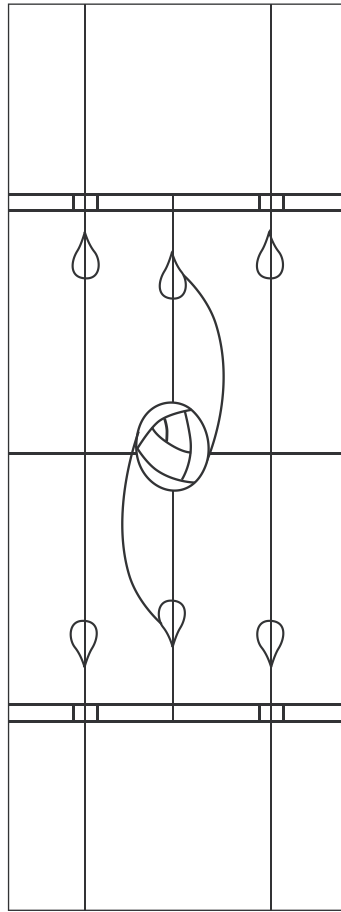

FGBC 188

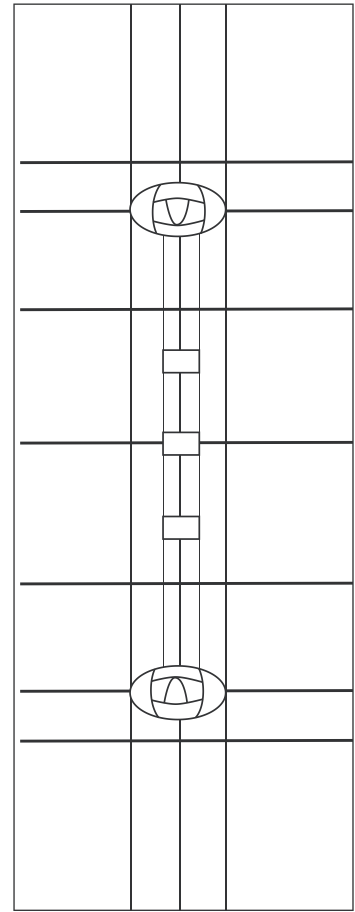

FGBC 193

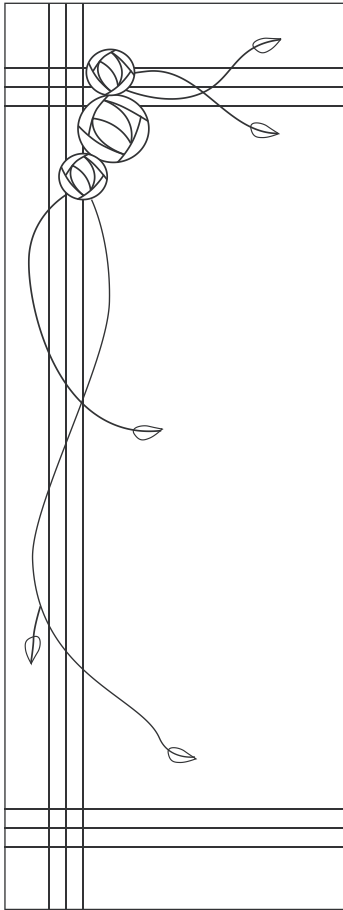

FGBC 190

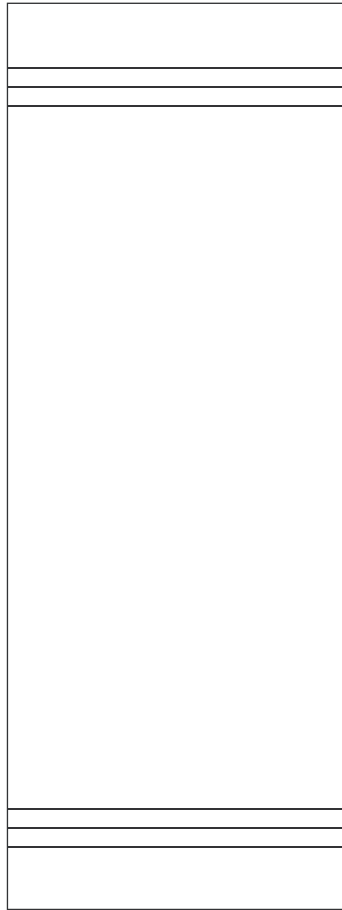

FGBC 191

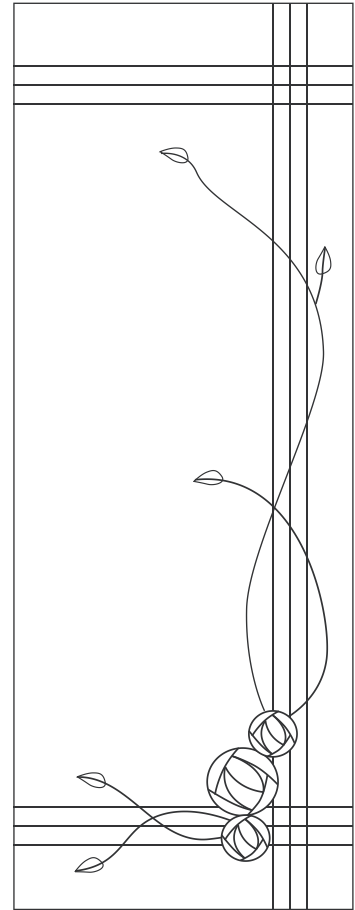

FGBC 192

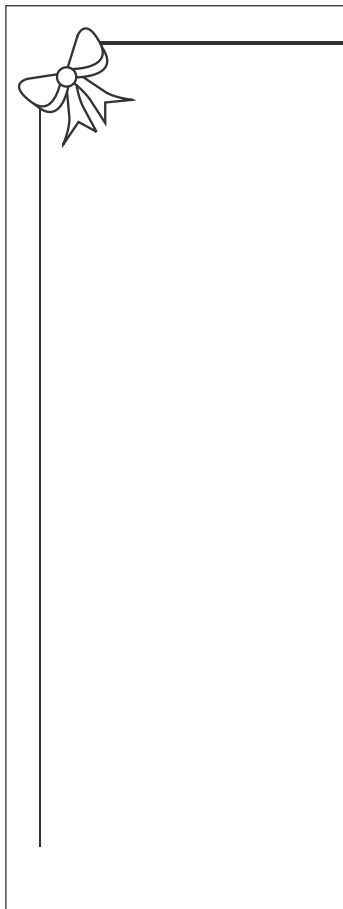

FGBC 301

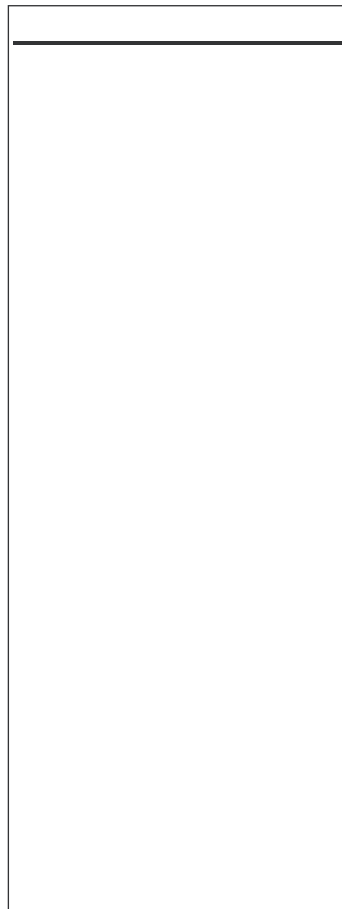

FGBC 302

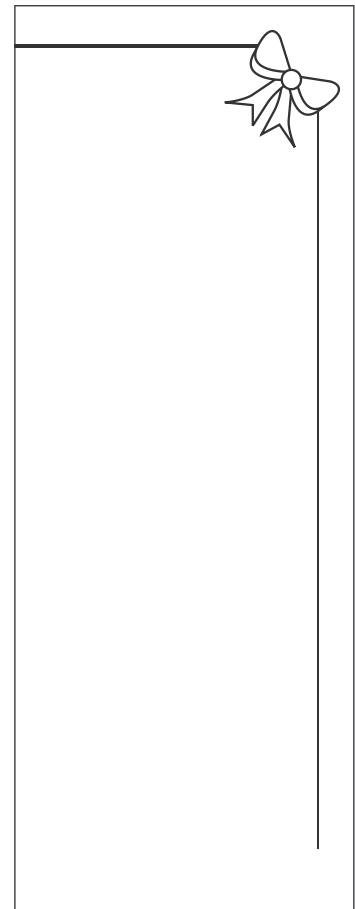

FGBC 303

BRILLIANT CUT, BEVELLED & POLISHED GLASS  
MIRRORS • PICTURE FRAMES • HARDWOOD DOORS

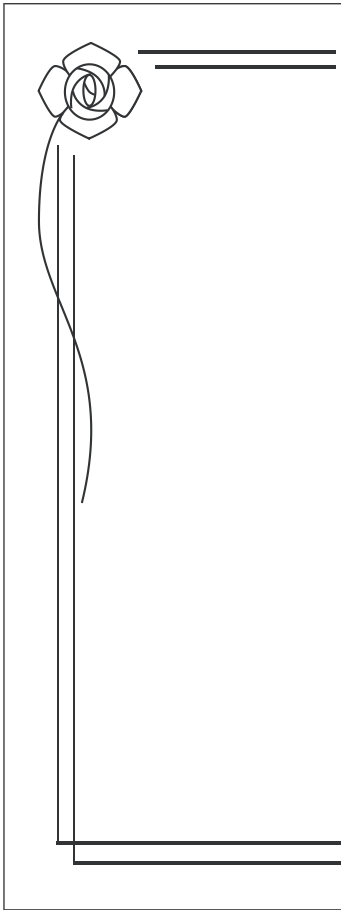

FGBC 304

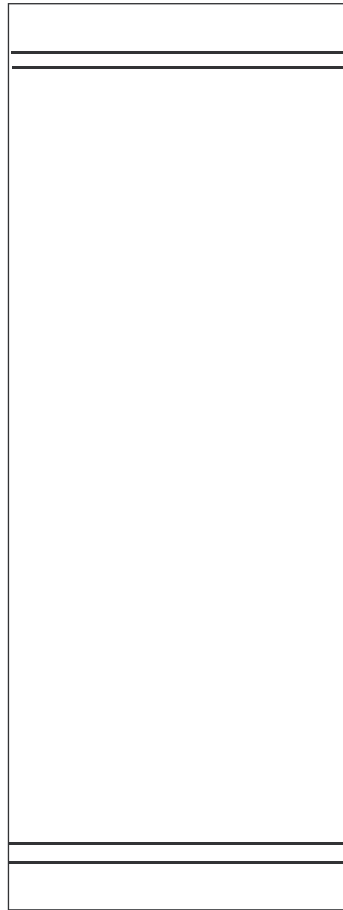

FGBC 305

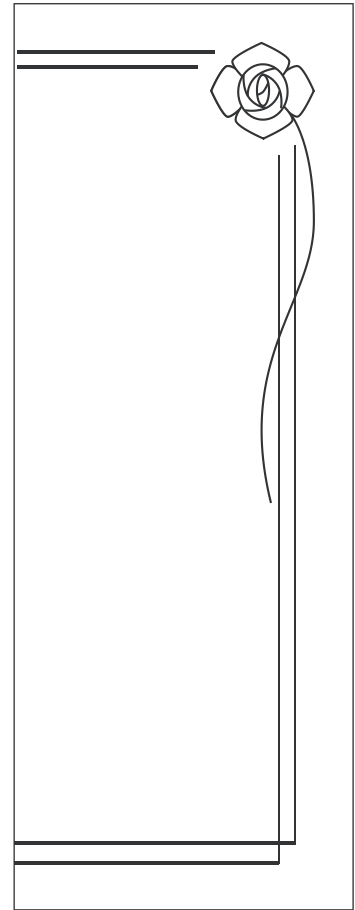

FGBC 306

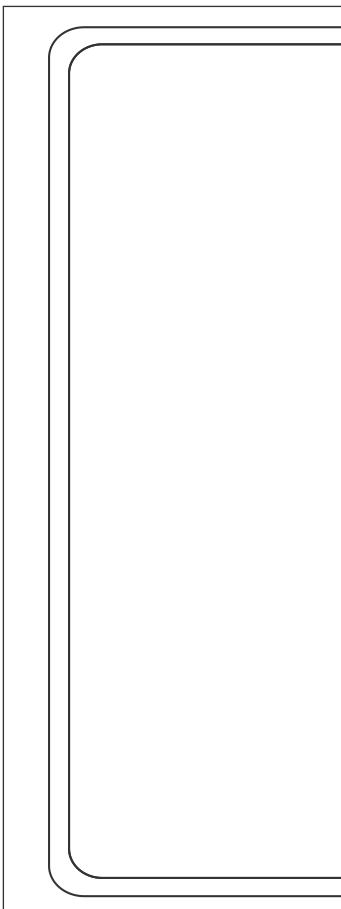

FGBC 307

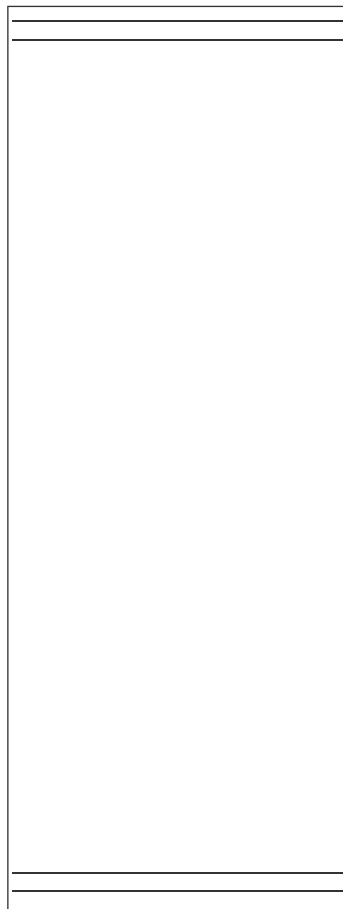

FGBC 308

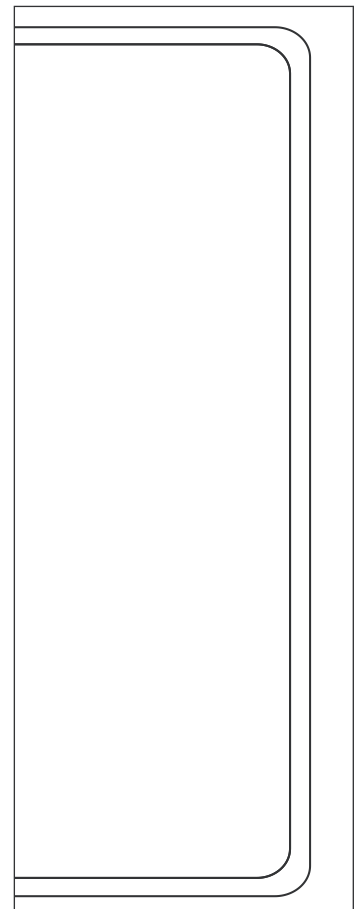

FGBC 309



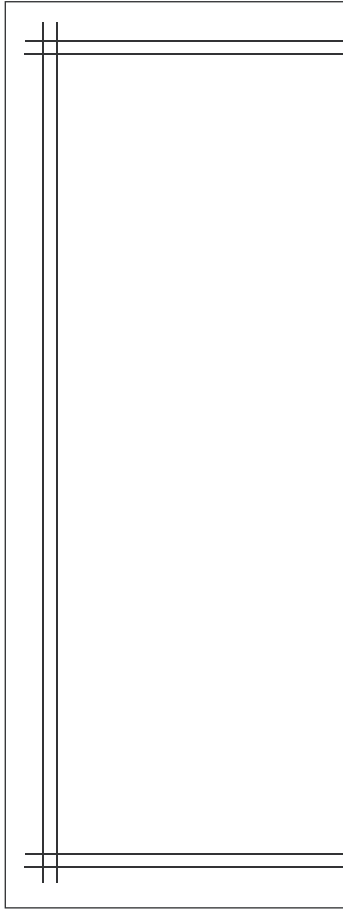

FGBC 310

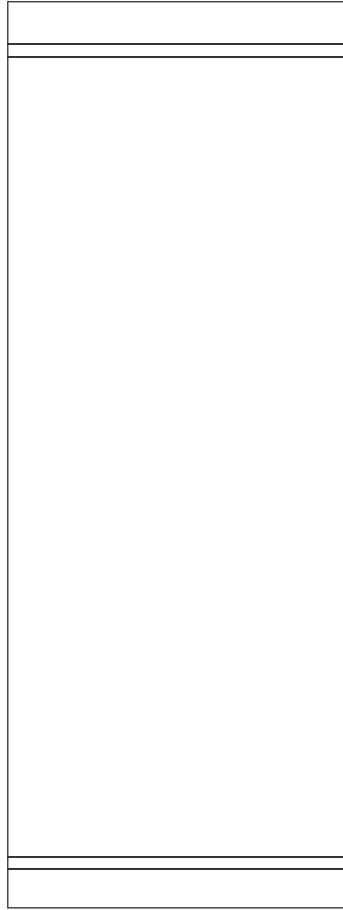

FGBC 311

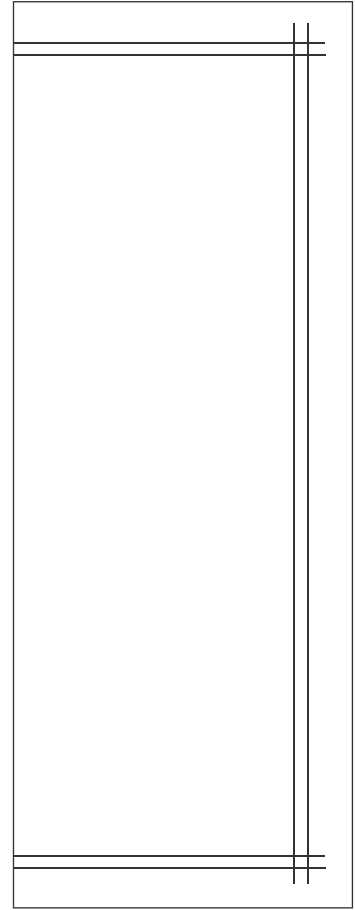

FGBC 312

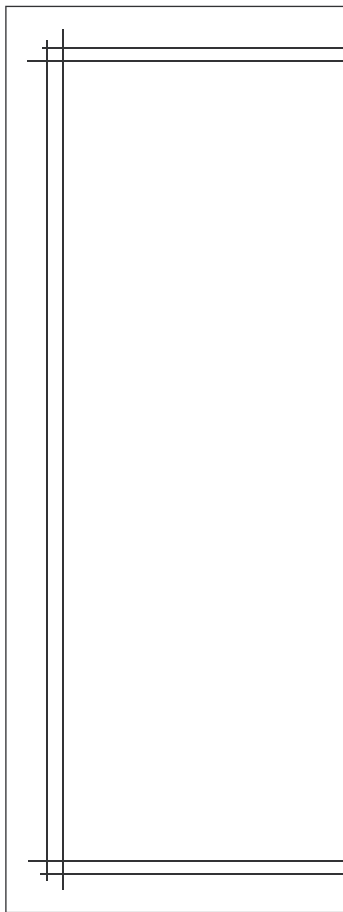

FGBC 313

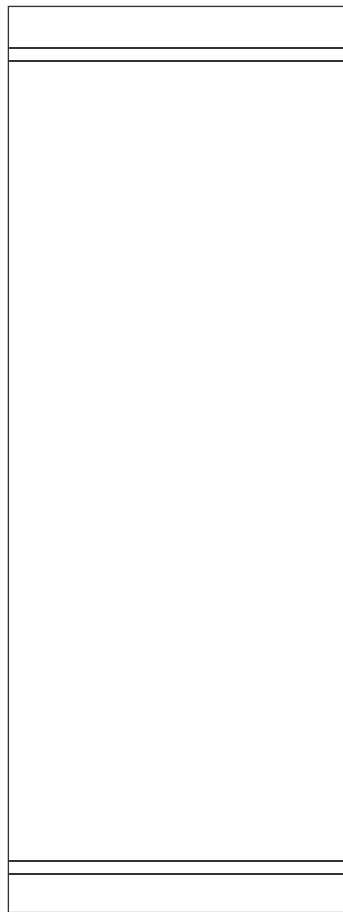

FGBC 314

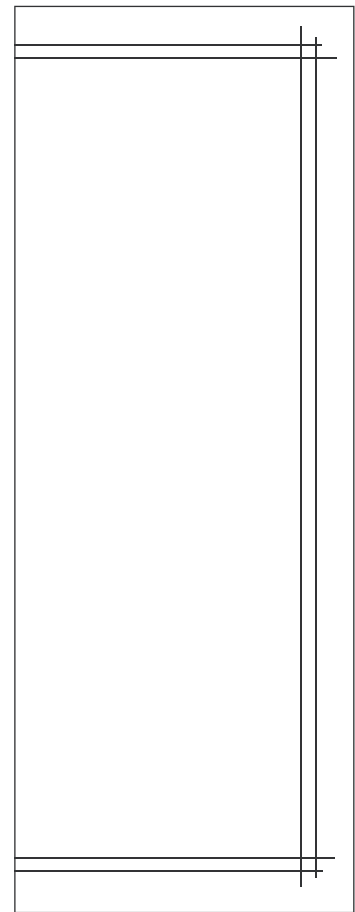

FGBC 315

BRILLIANT CUT, BEVELLED & POLISHED GLASS  
MIRRORS • PICTURE FRAMES • HARDWOOD DOORS

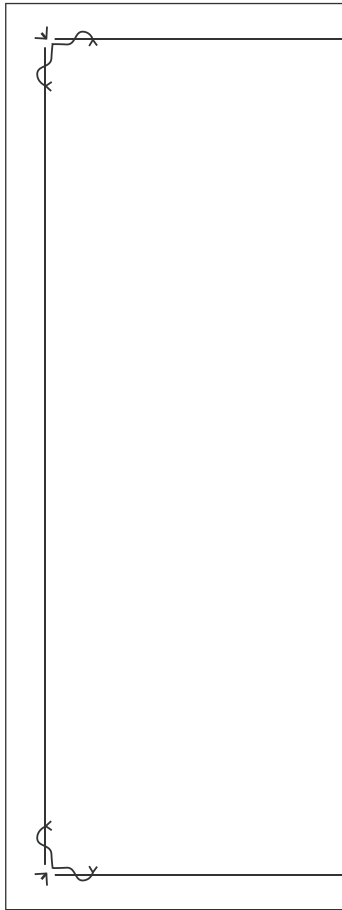

FGBC 316

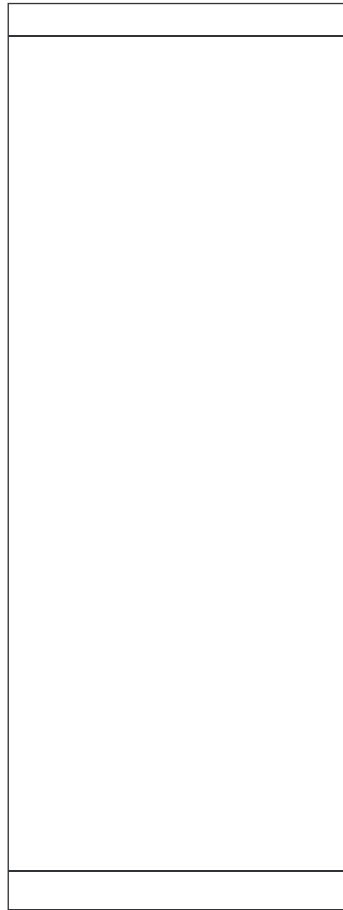

FGBC 317

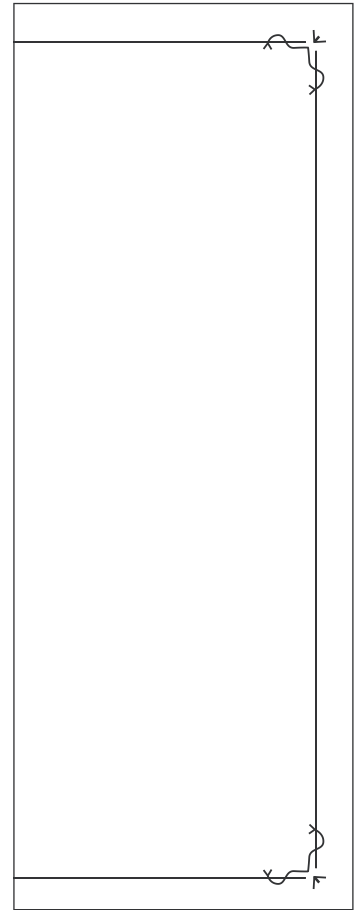

FGBC 318

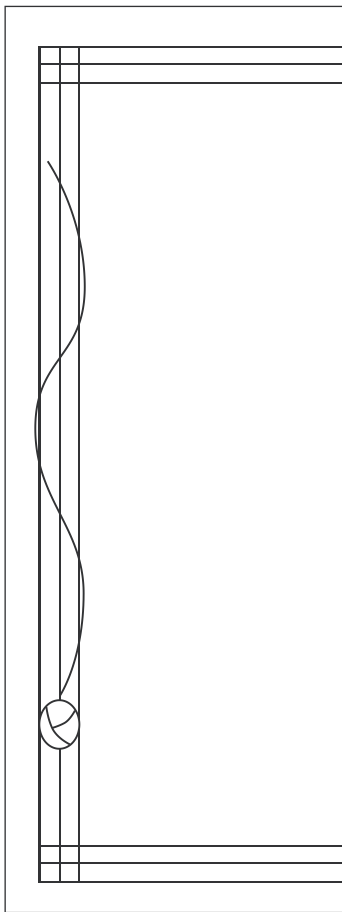

FGBC 319

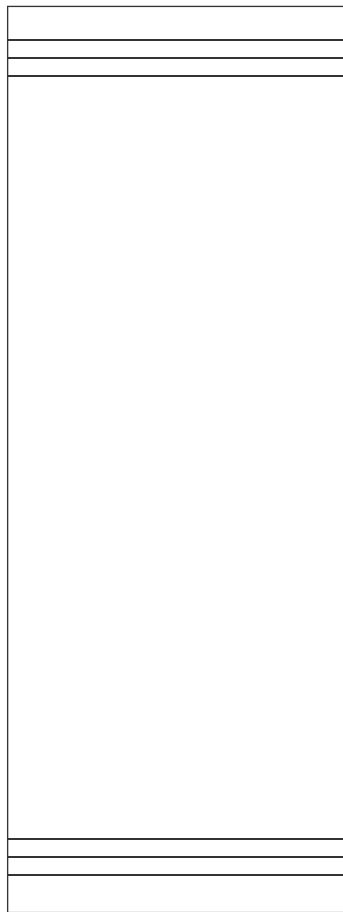

FGBC 320

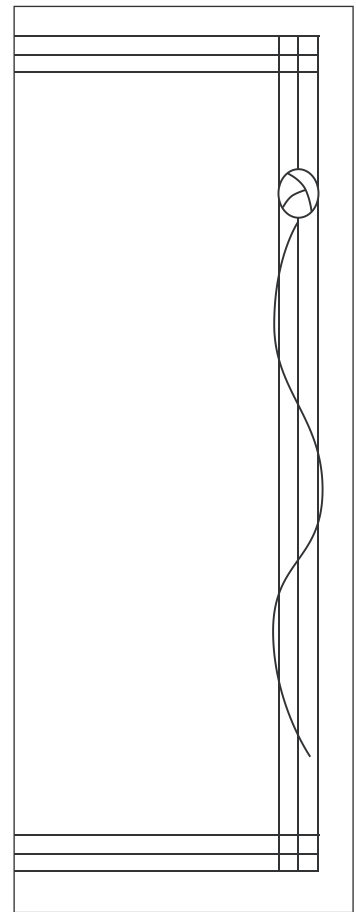

FGBC 321

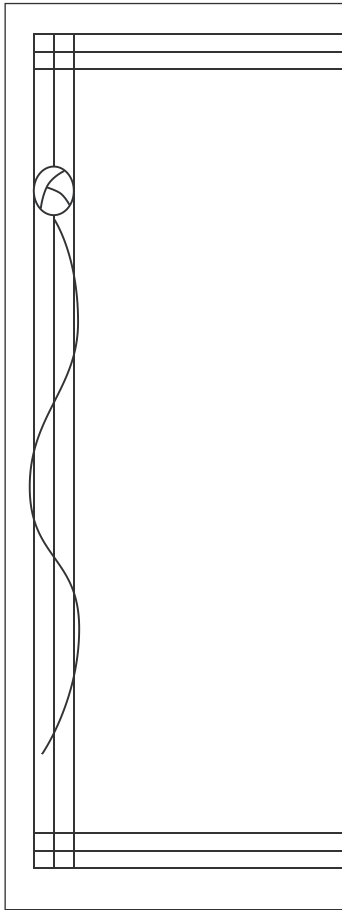

FGBC 322

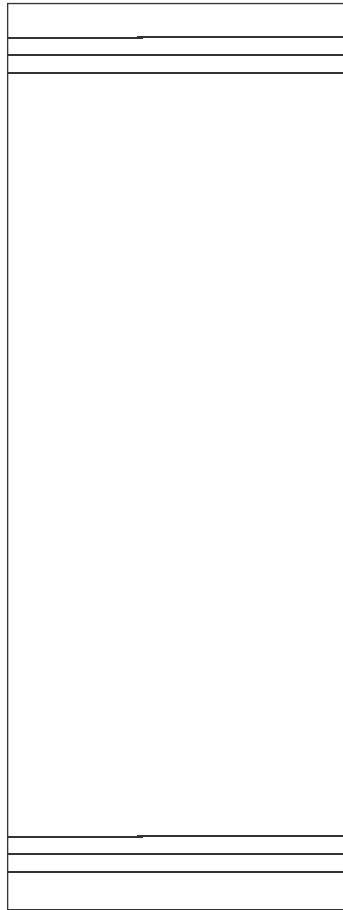

FGBC 323

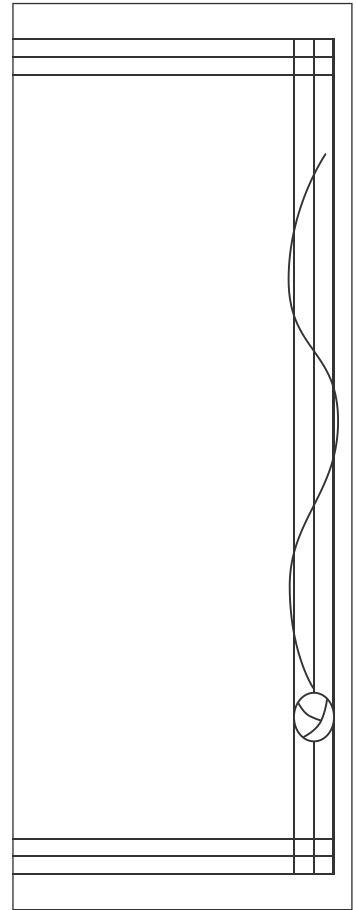

FGBC 324

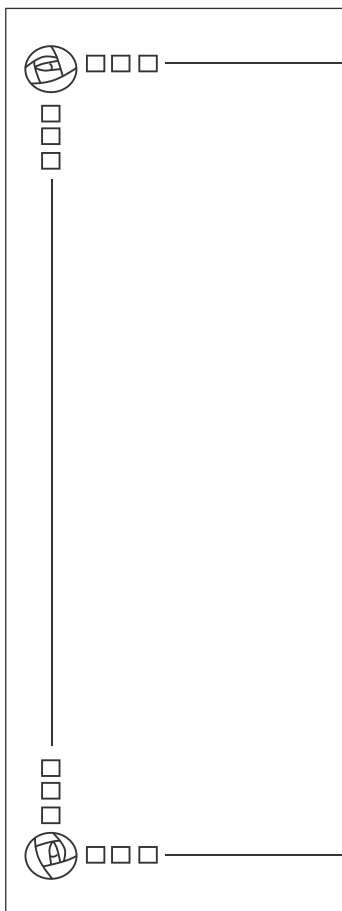

FGBC 325

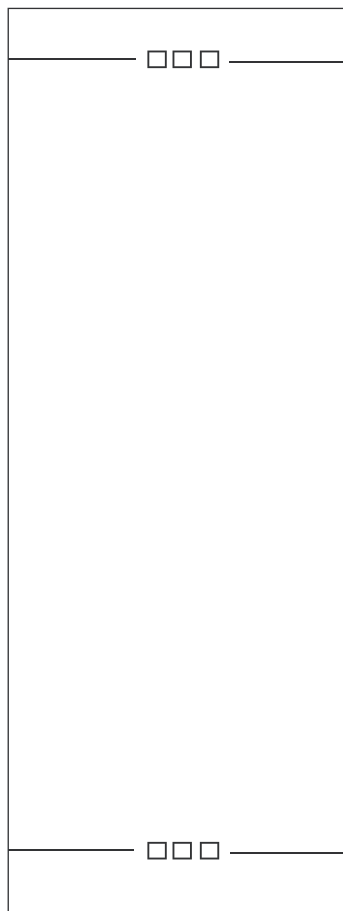

FGBC 326

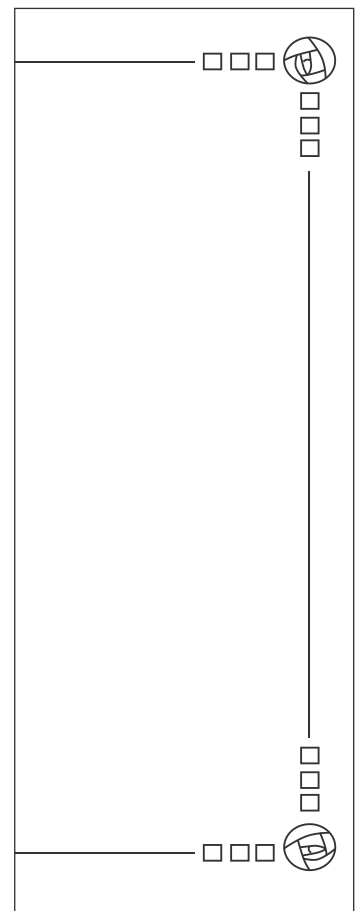

FGBC 327

BRILLIANT CUT, BEVELLED & POLISHED GLASS  
MIRRORS • PICTURE FRAMES • HARDWOOD DOORS

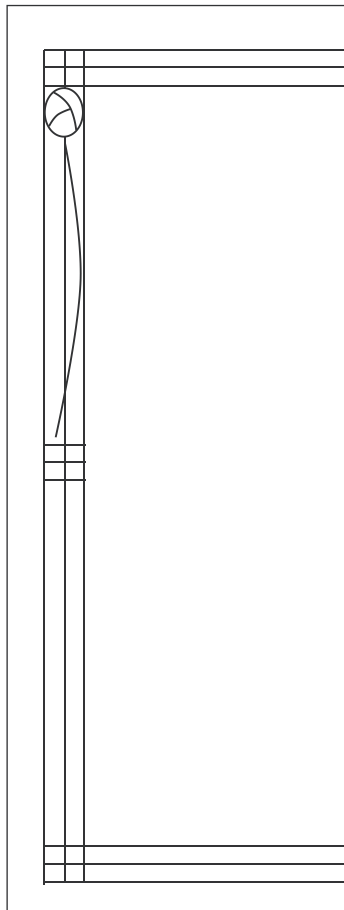

FGBC 328

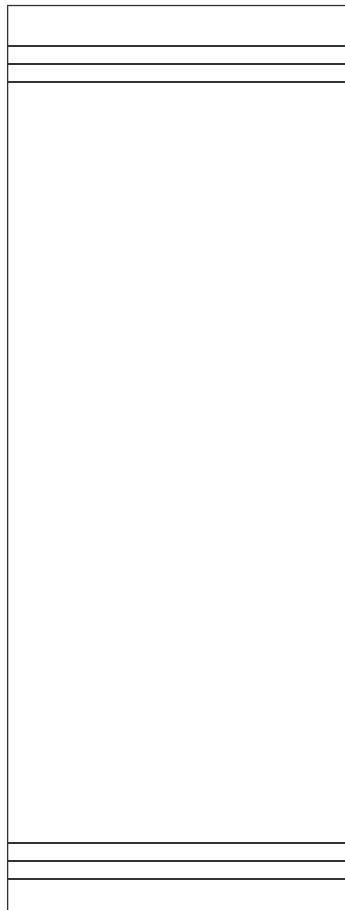

FGBC 329

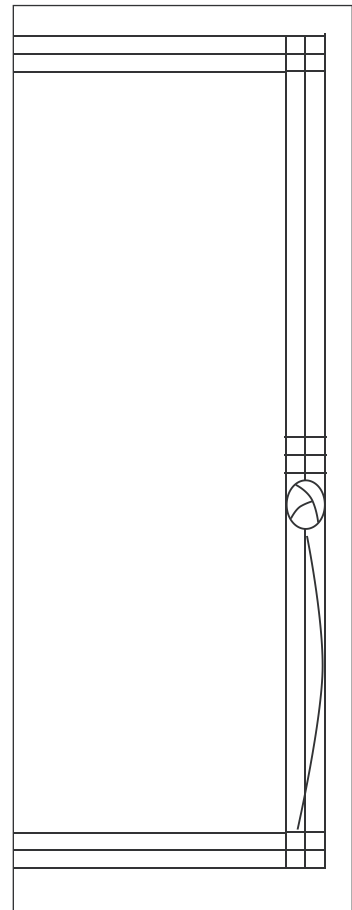

FGBC 330

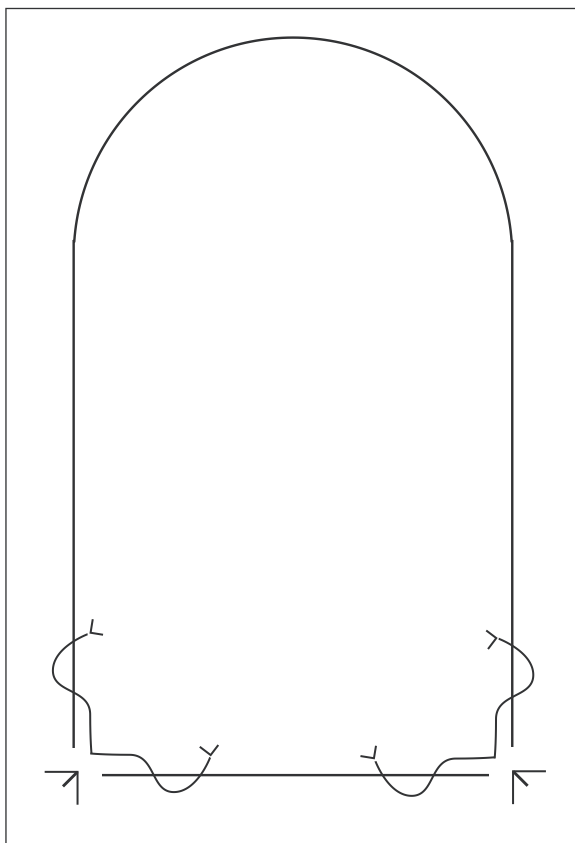

FGBC 401

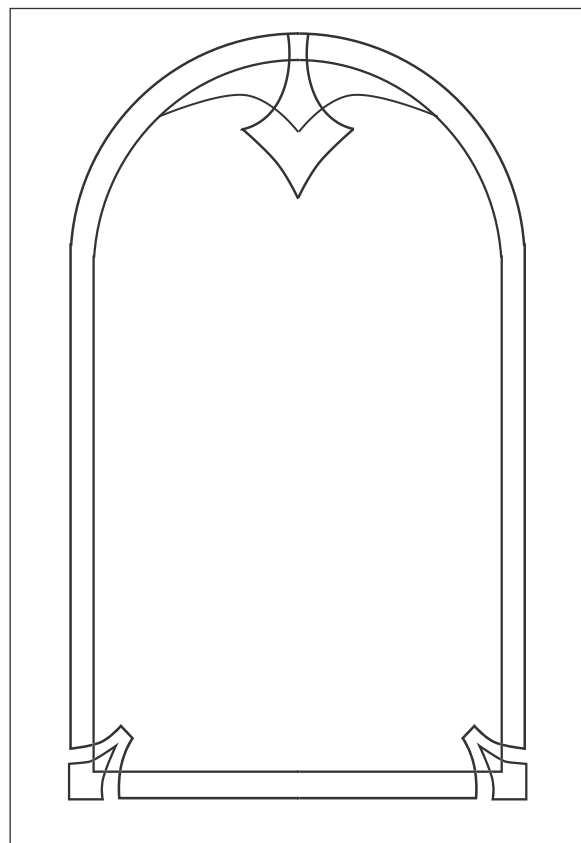

FGBC 402

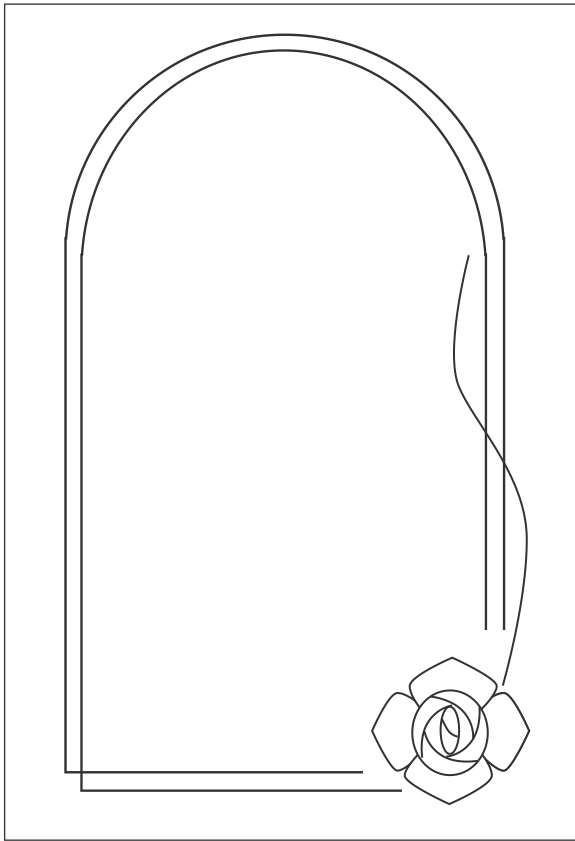

FGBC 403

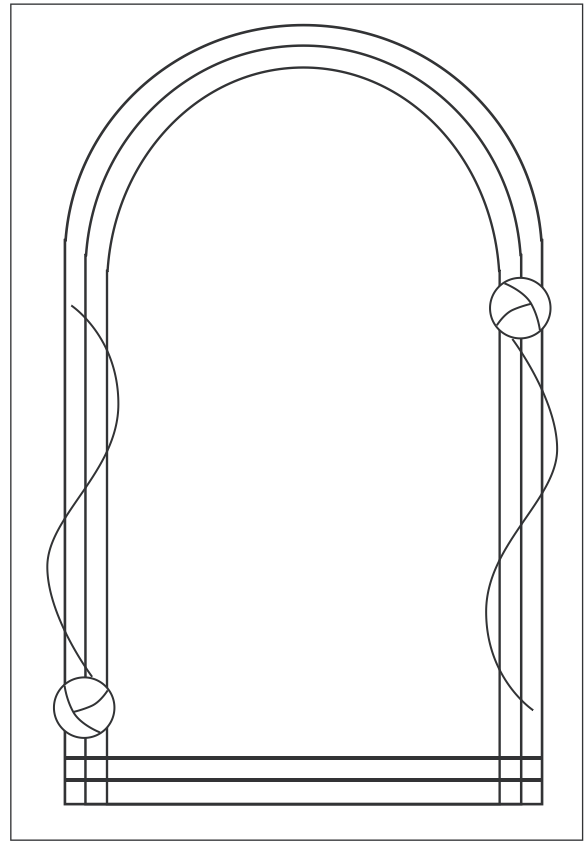

FGBC 404

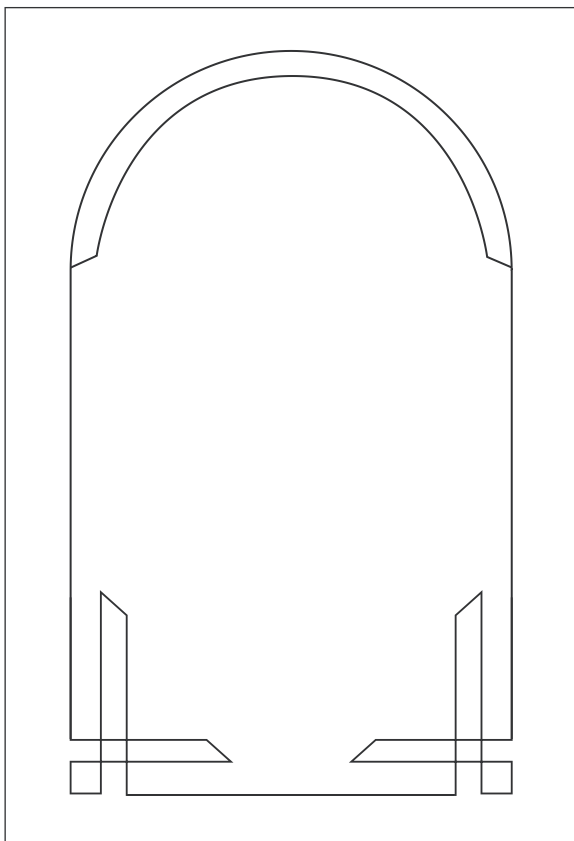

FGBC 405

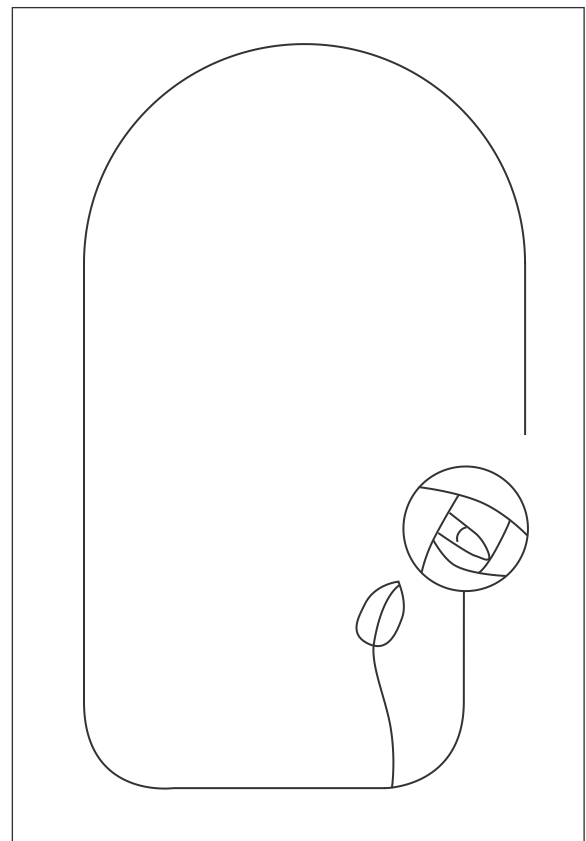

FGBC 406

BRILLIANT CUT, BEVELLED & POLISHED GLASS  
MIRRORS • PICTURE FRAMES • HARDWOOD DOORS

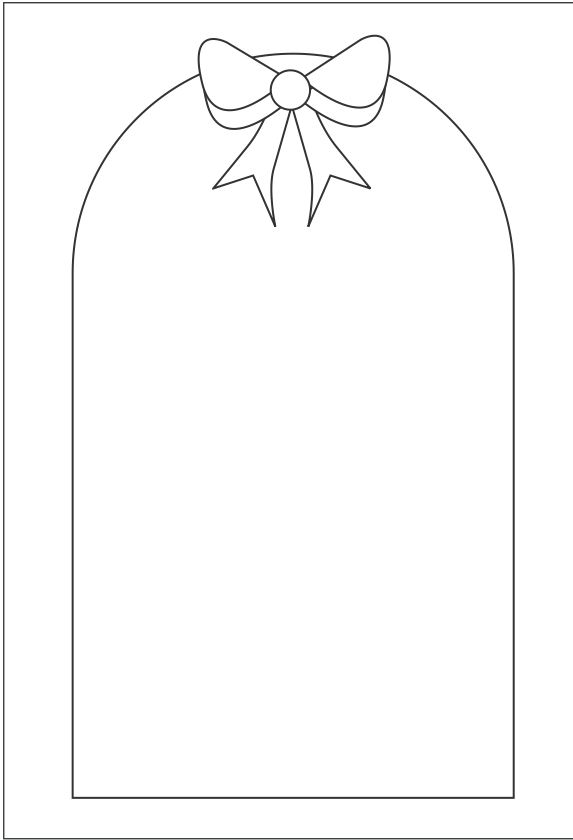

FGBC 407

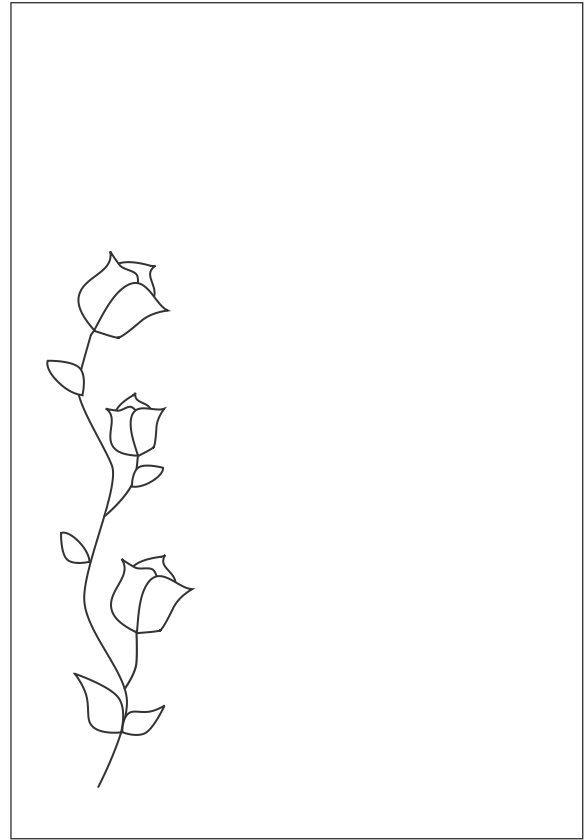

FGBC 408

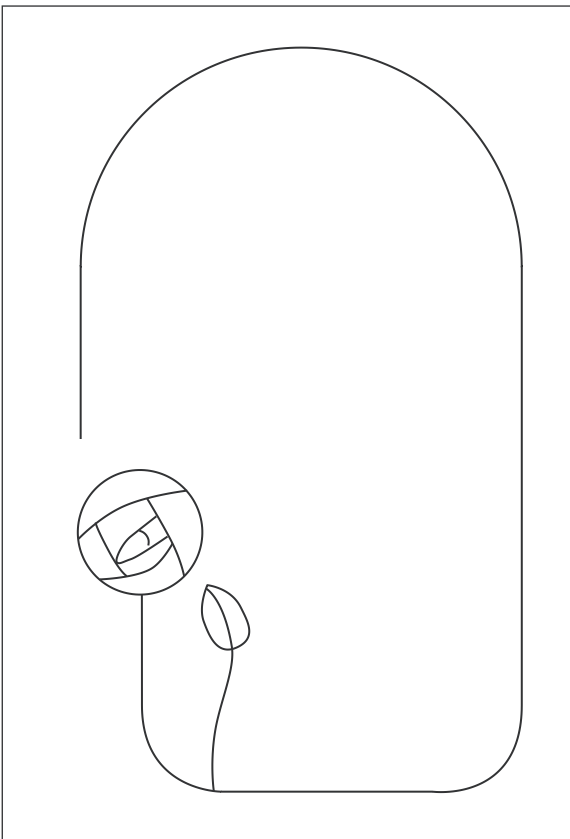

FGBC 409

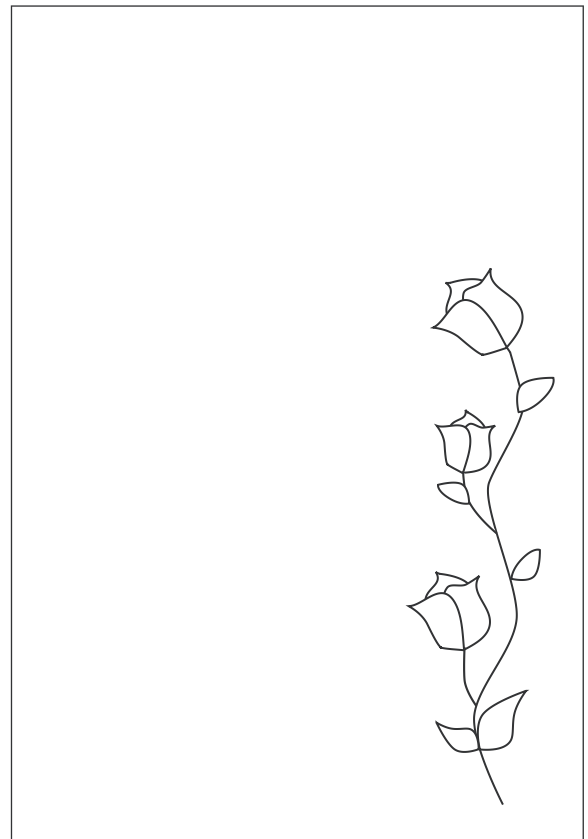

FGBC 410

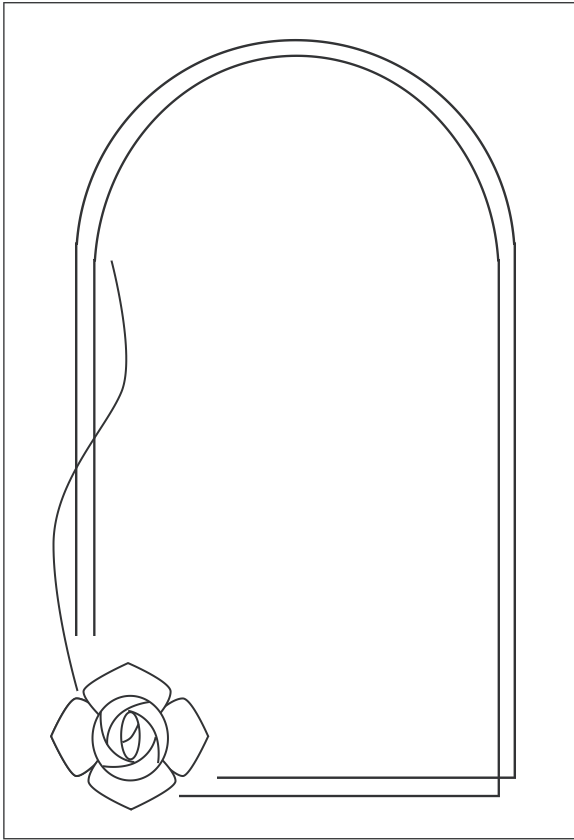

FGBC 411

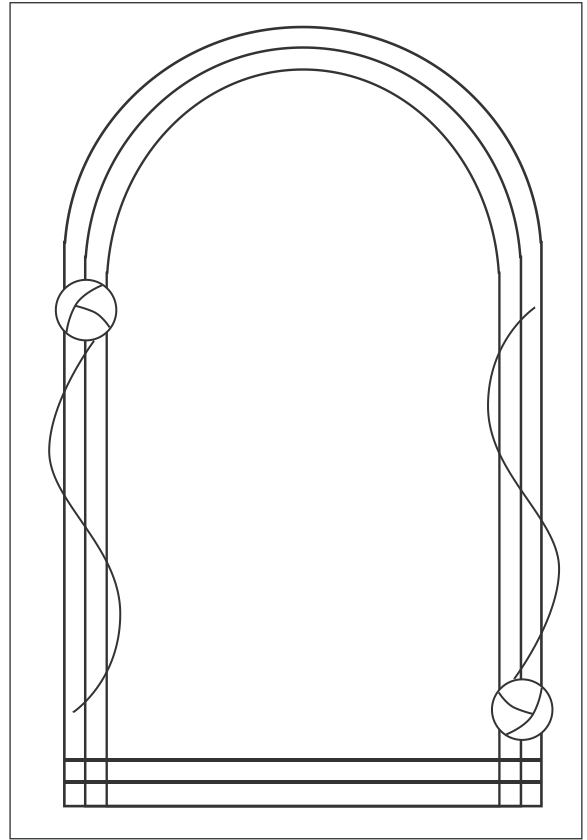

FGBC 412

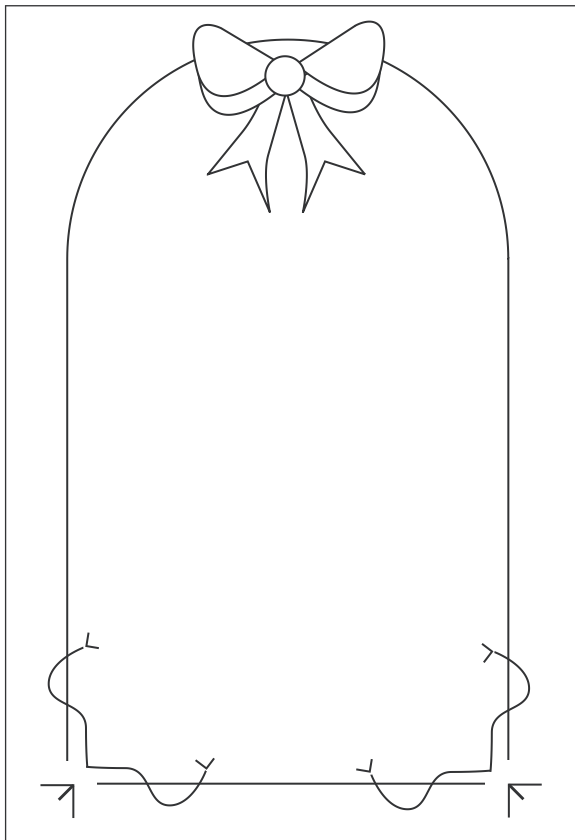

FGBC 413

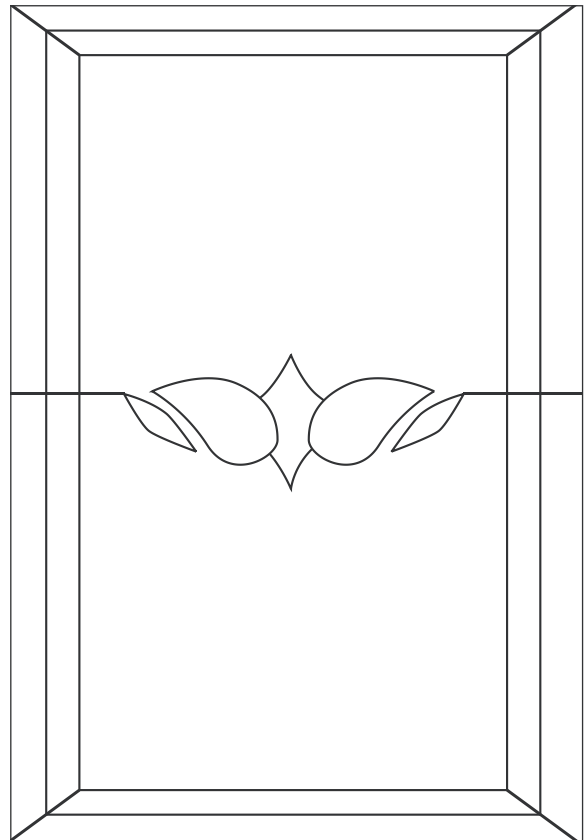

FGBC 414

BRILLIANT CUT, BEVELLED & POLISHED GLASS  
MIRRORS • PICTURE FRAMES • HARDWOOD DOORS

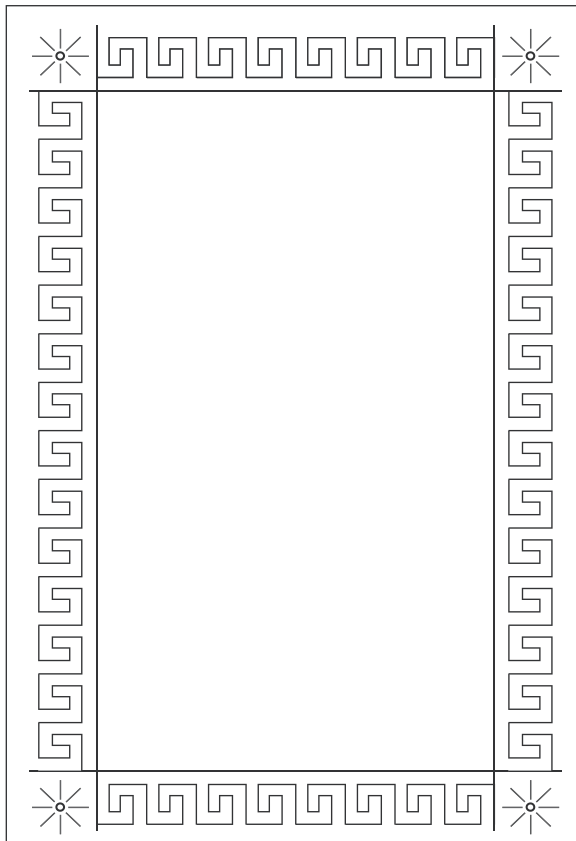

FGBC 415

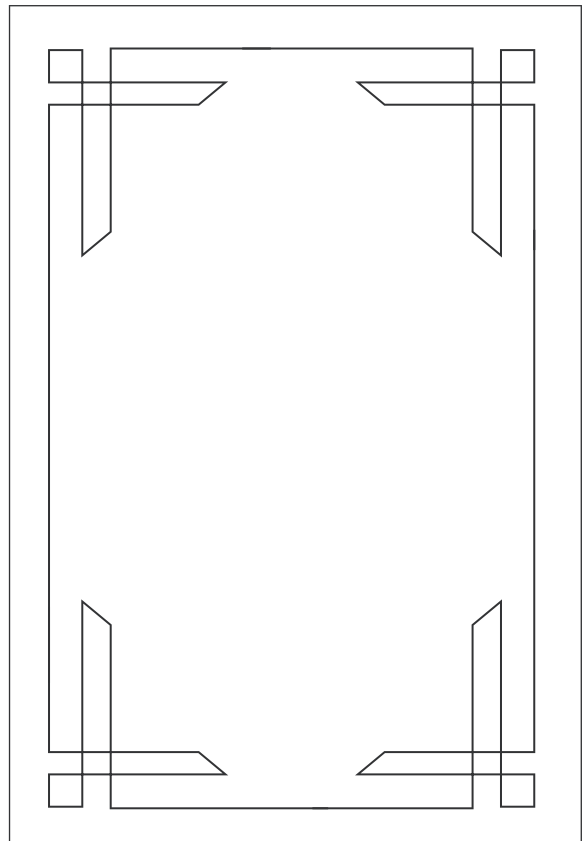

FGBC 416

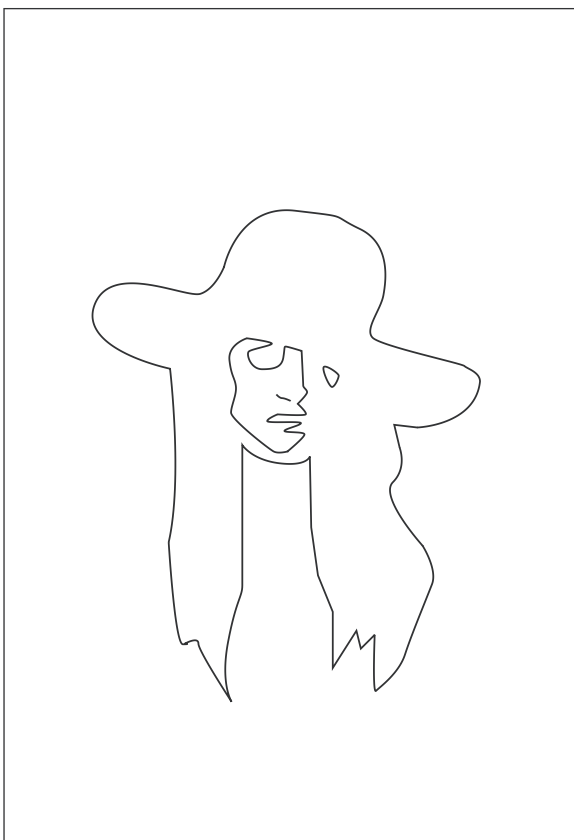

FGBC 417

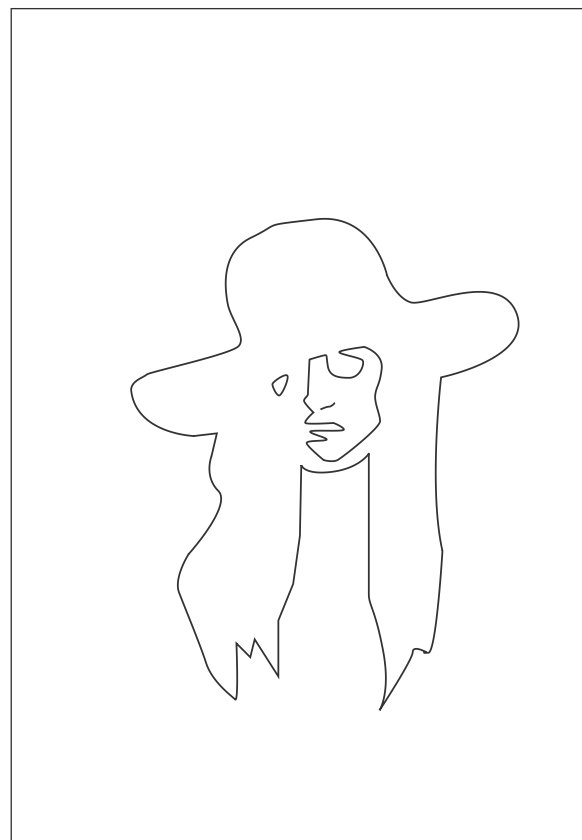

FGBC 418



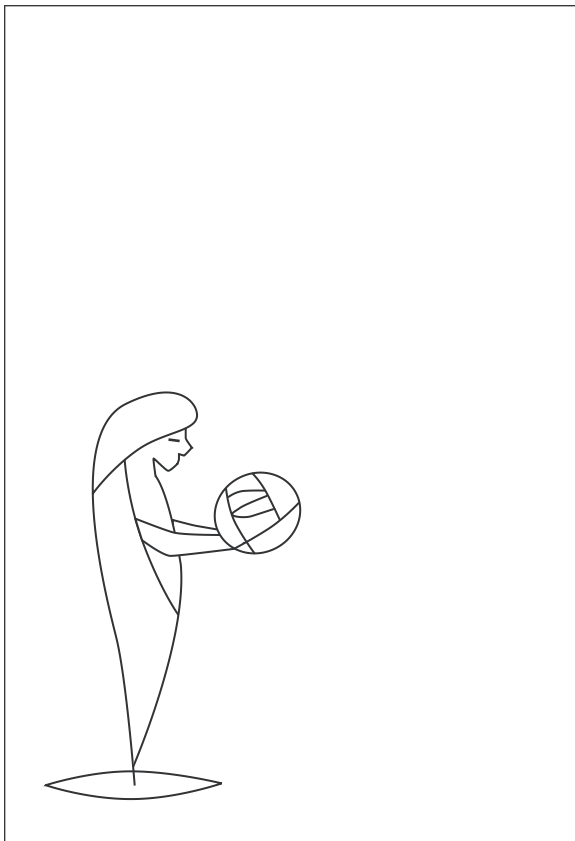

FGBC 419

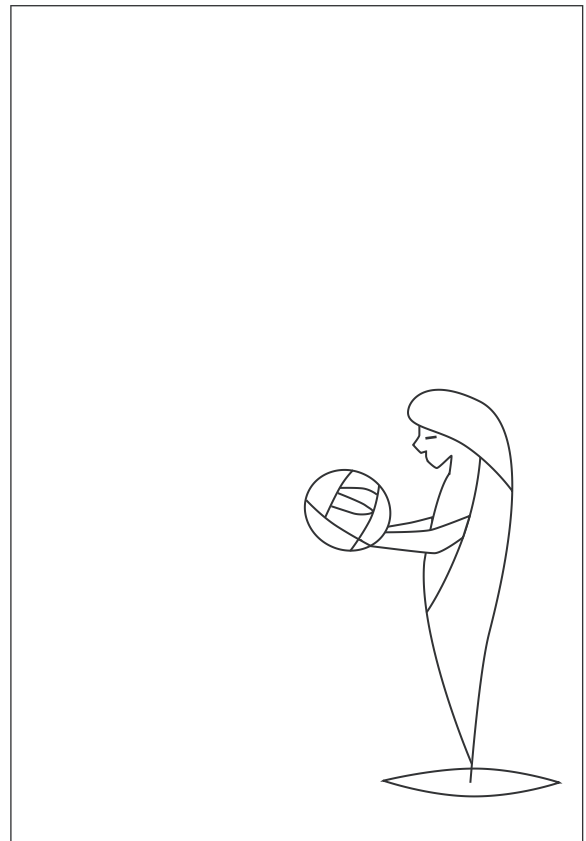

FGBC 420

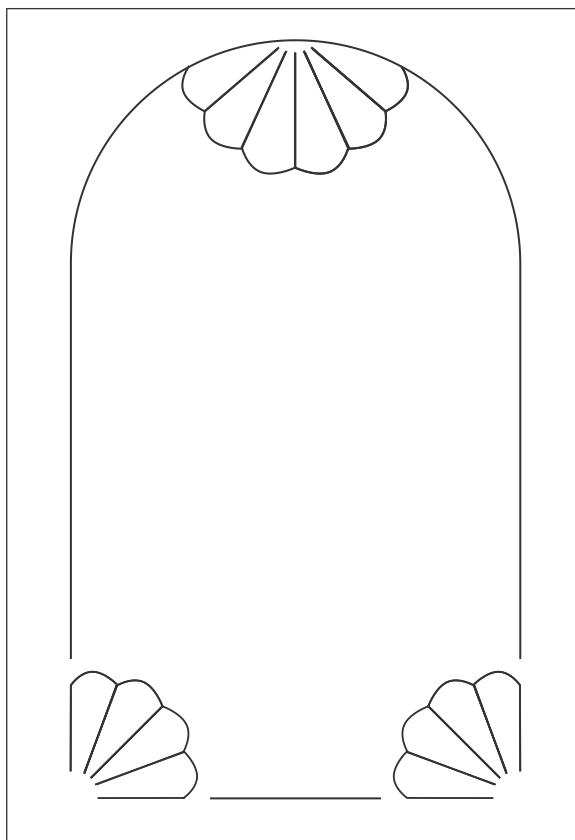

FGBC 421

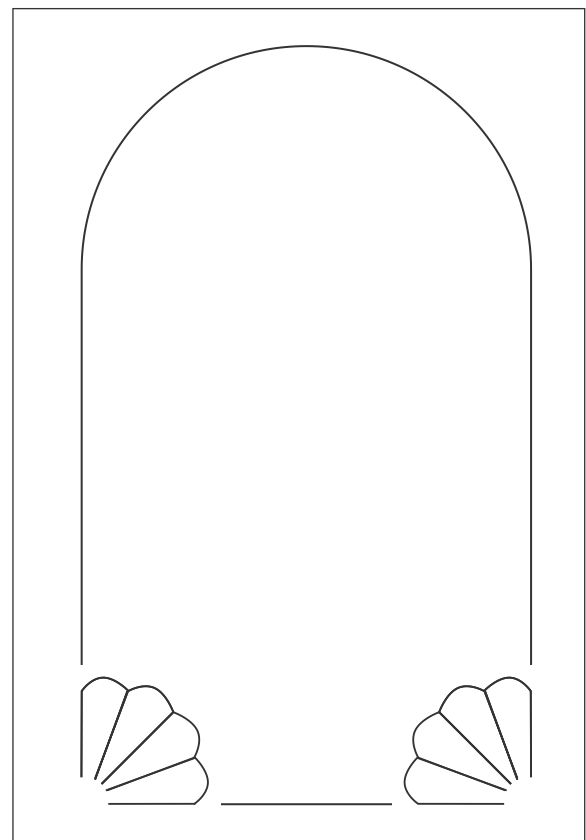

FGBC 422

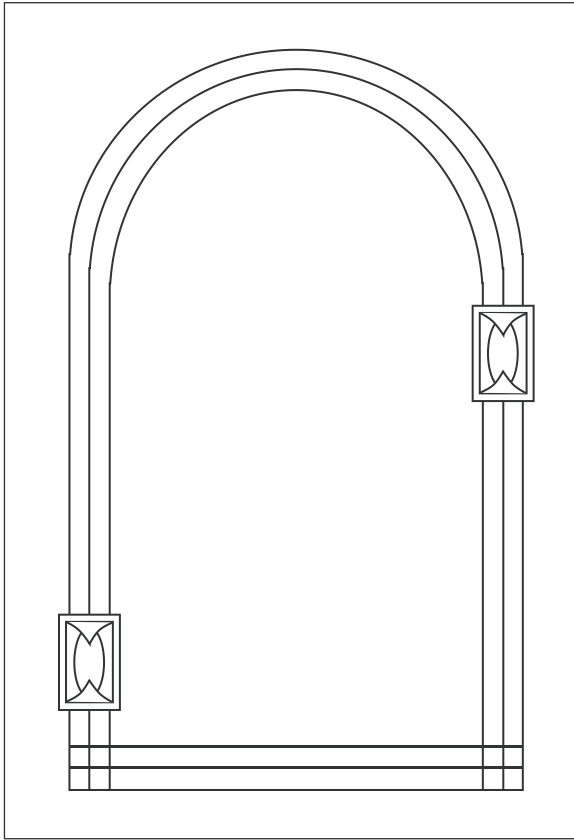

FGBC 423

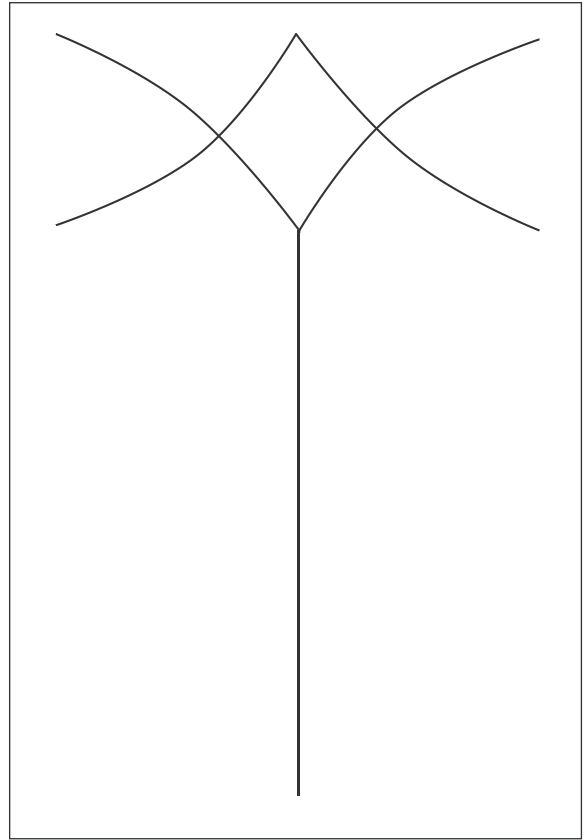

FGBC 424

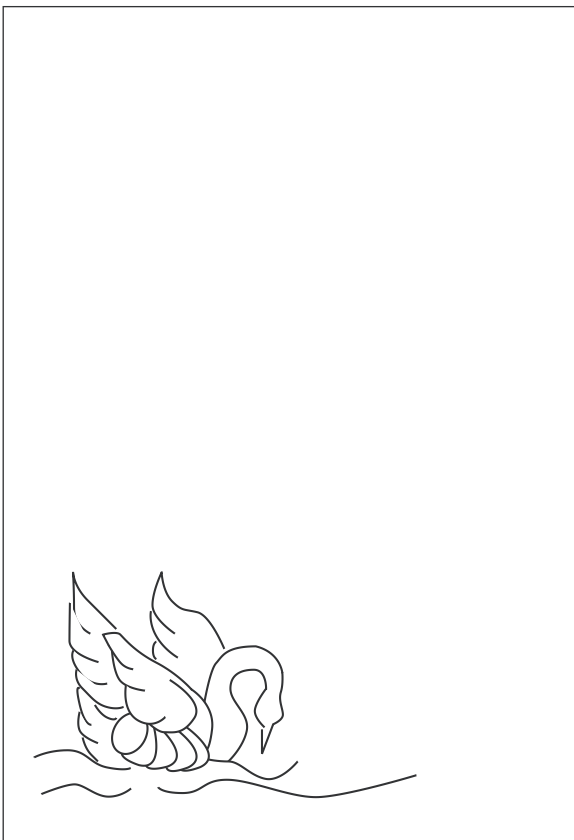

FGBC 425



FGBC 426

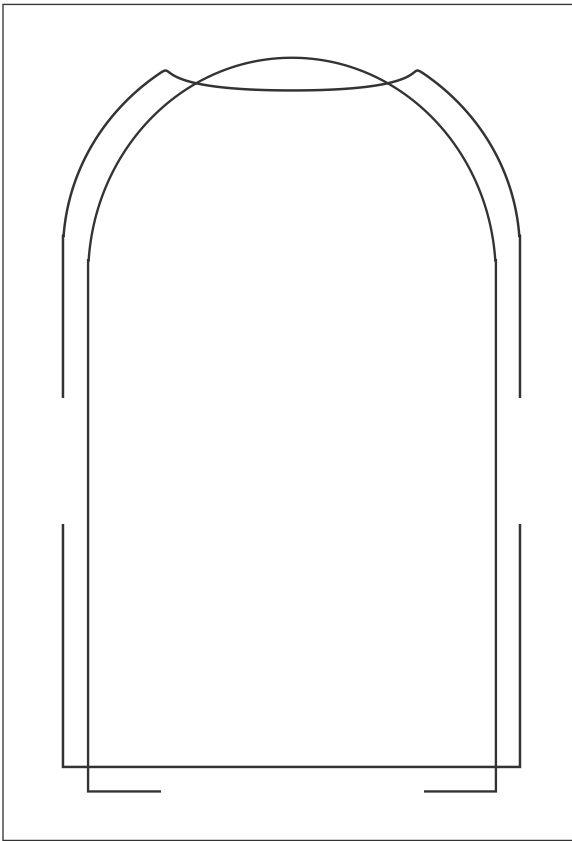

FGBC 427

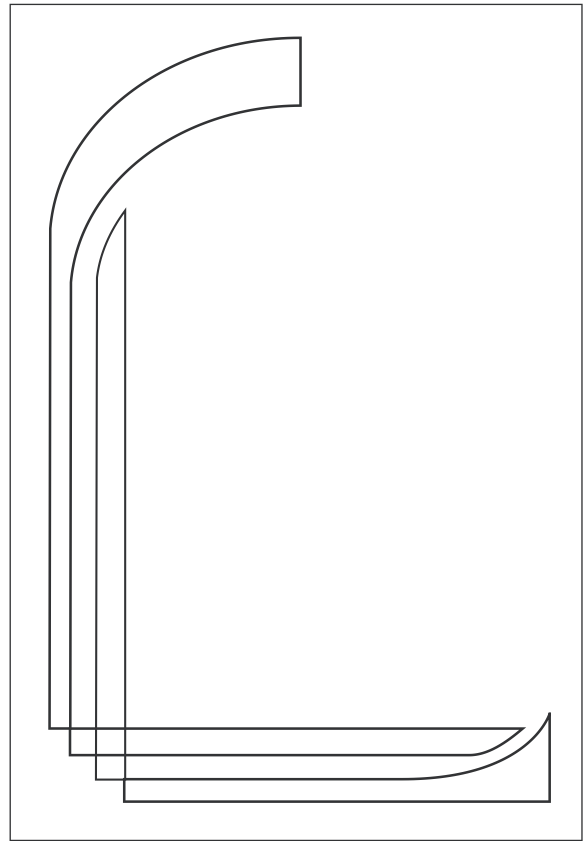

FGBC 428

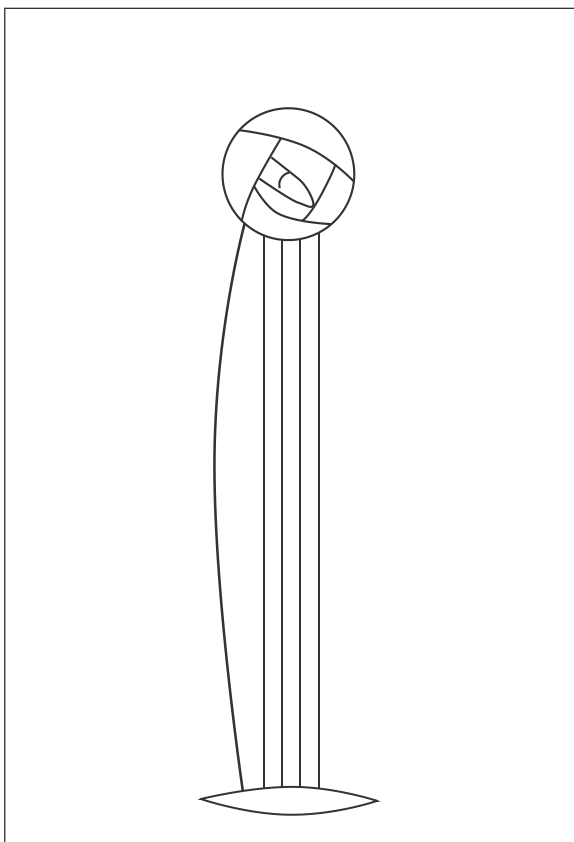

FGBC 429

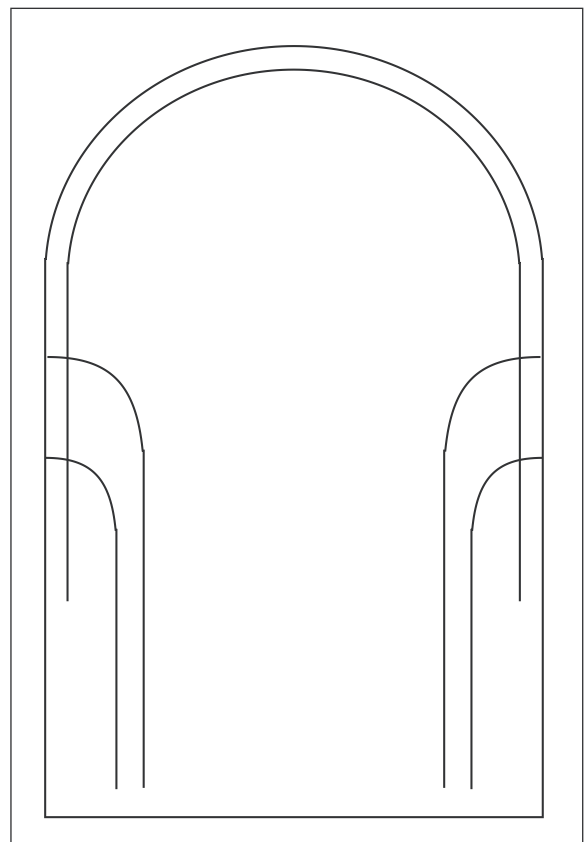

FGBC 430

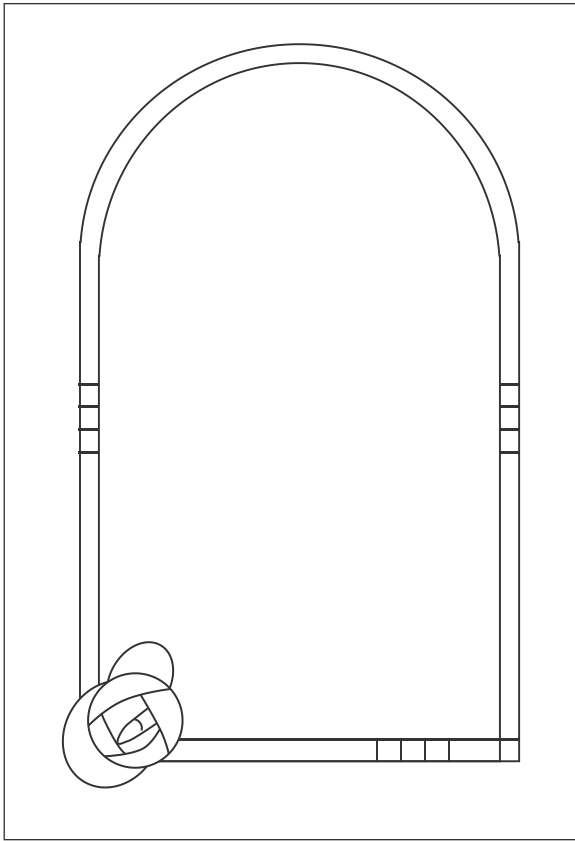

FGBC 431

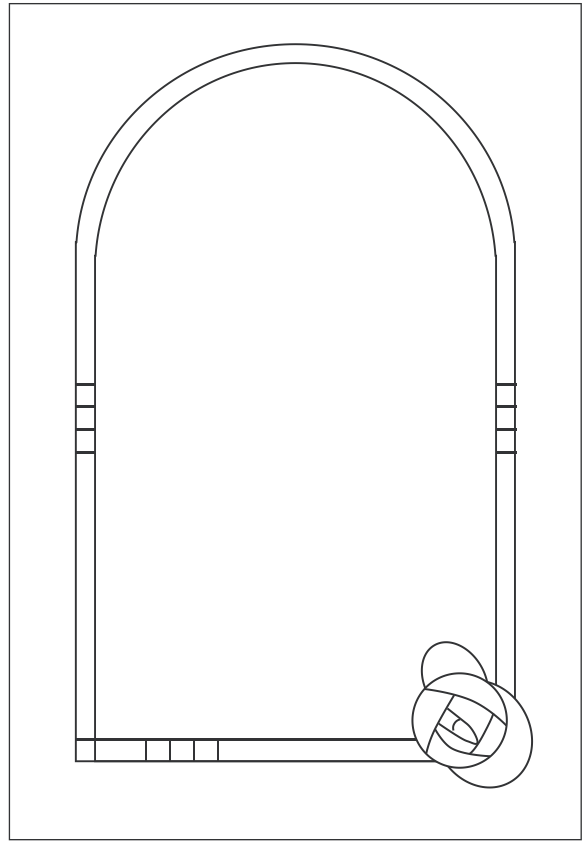

FGBC 432

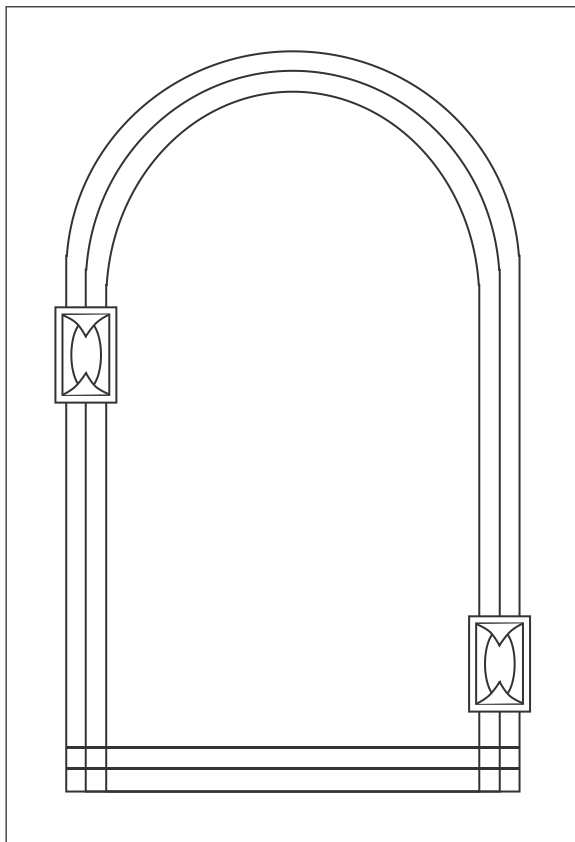

FGBC 433

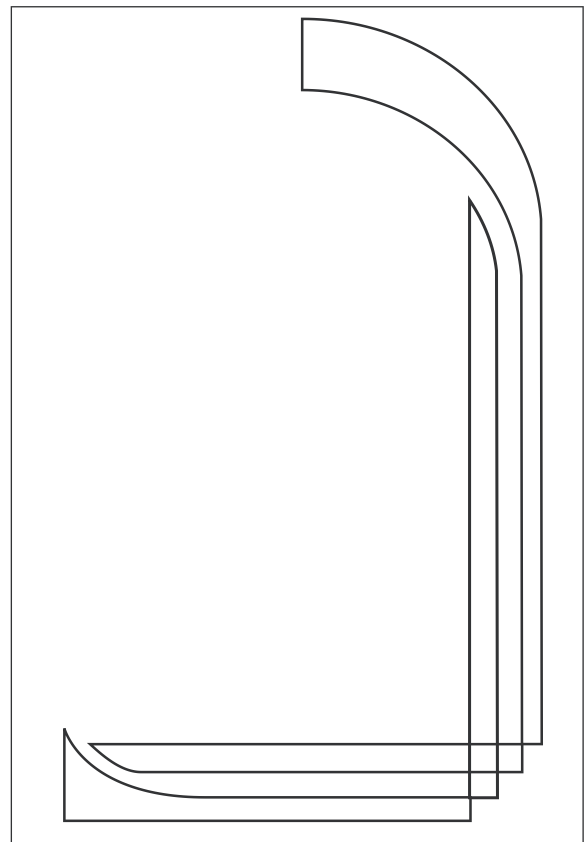

FGBC 434

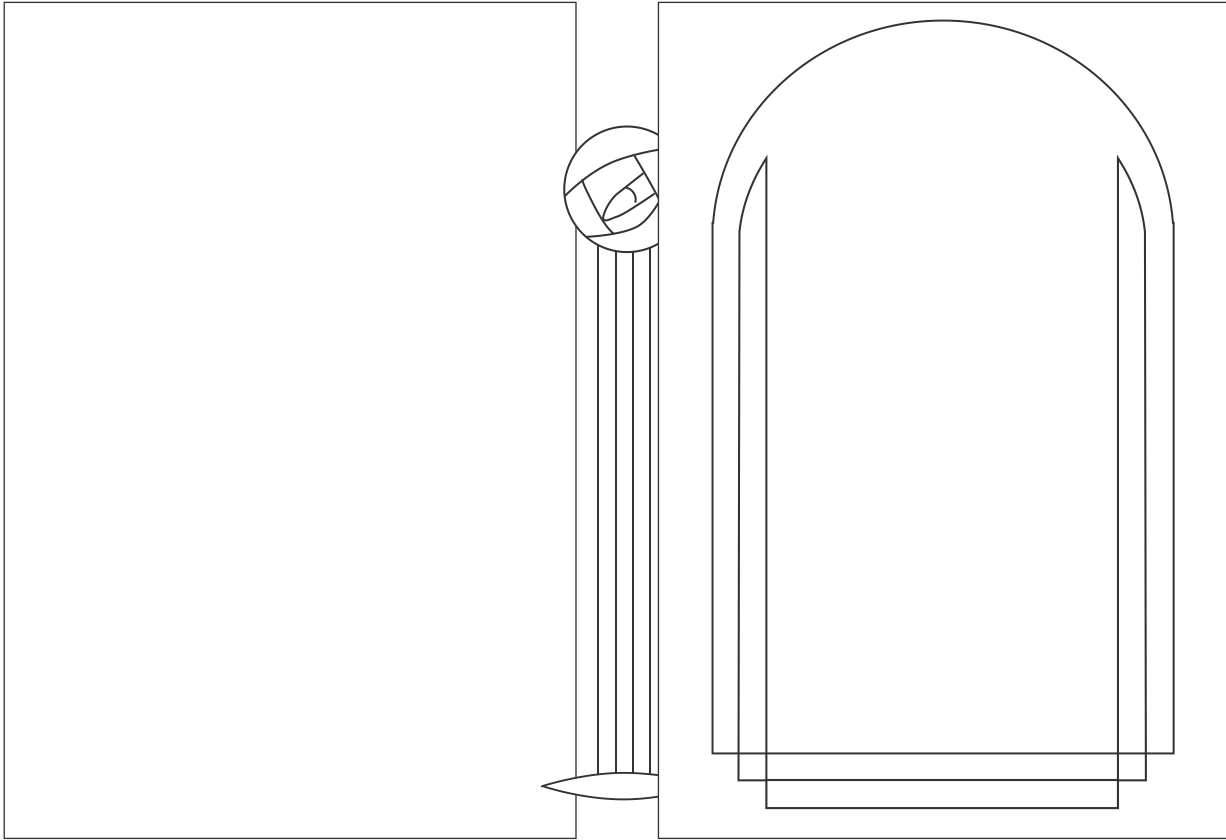

FGBC 435

FGBC 436

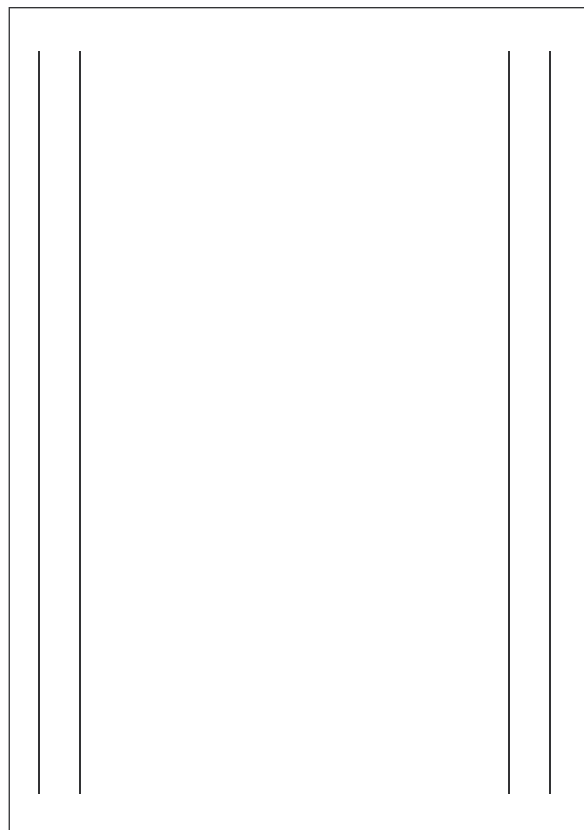

FGBC 537

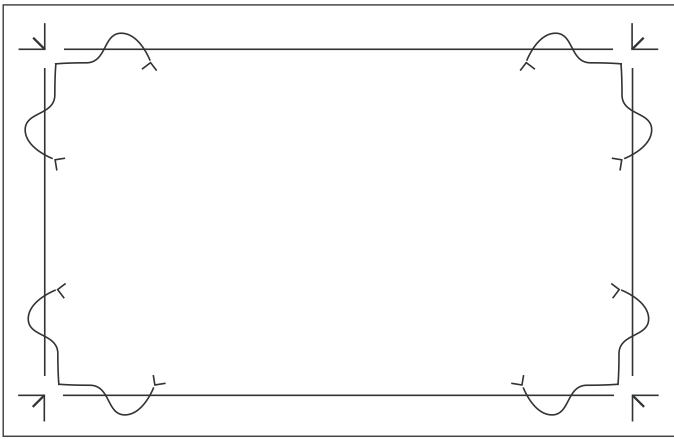

FGBC 501

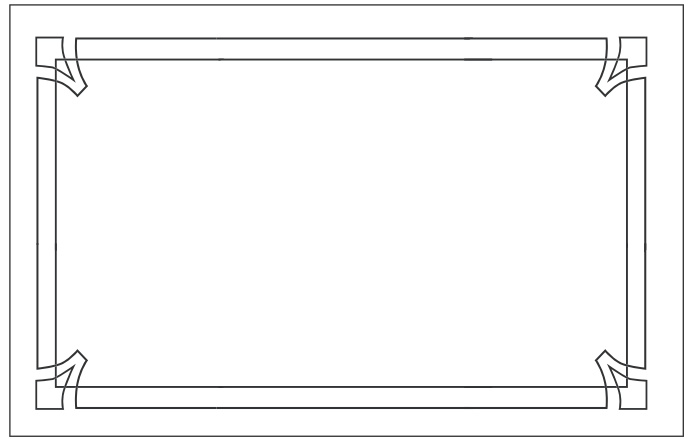

FGBC 502

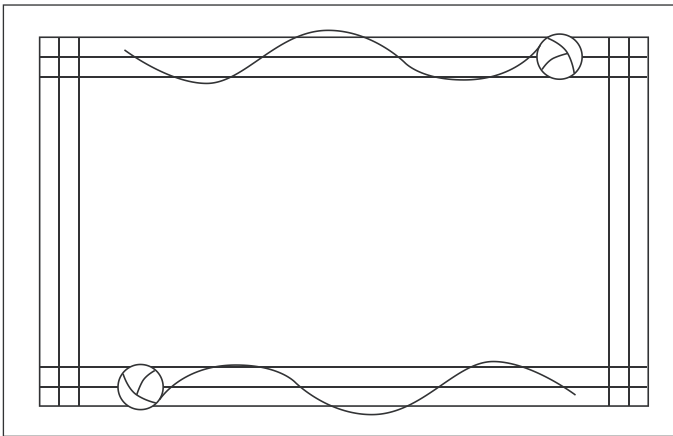

FGBC 503

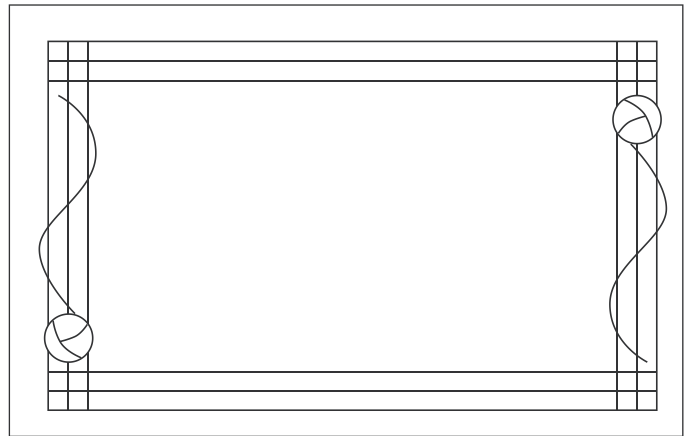

FGBC 504

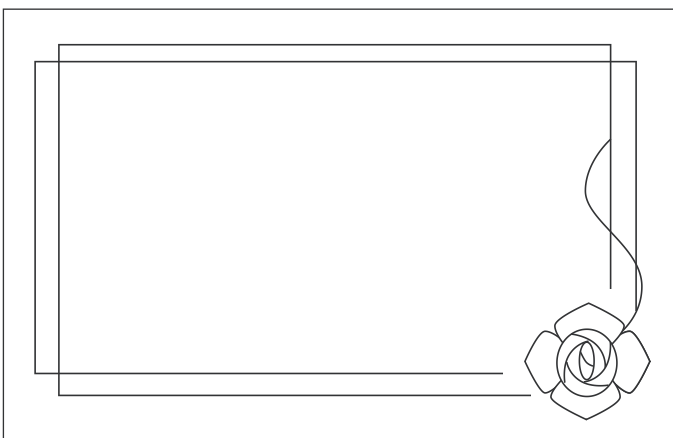

FGBC 505

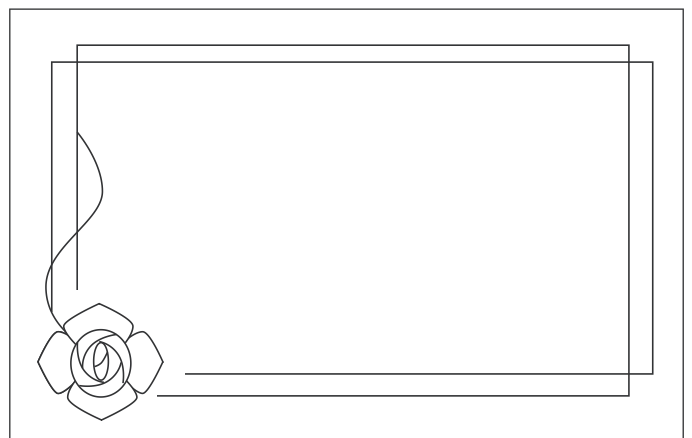

FGBC 506

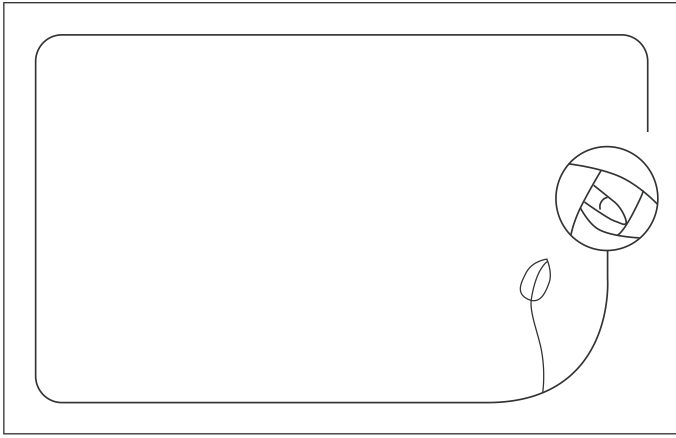

FGBC

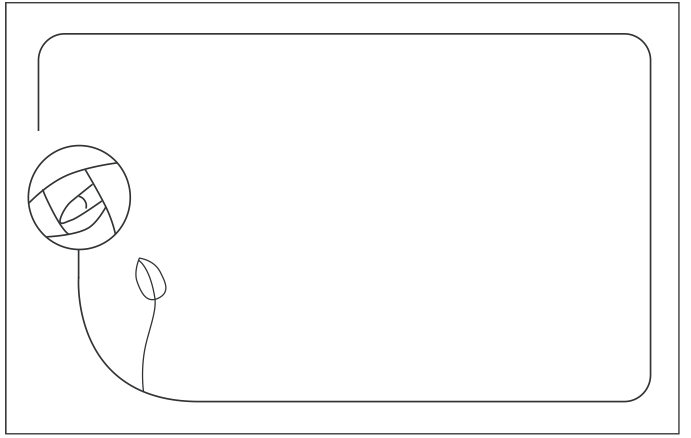

FGBC



FGBC



FGBC



FGBC

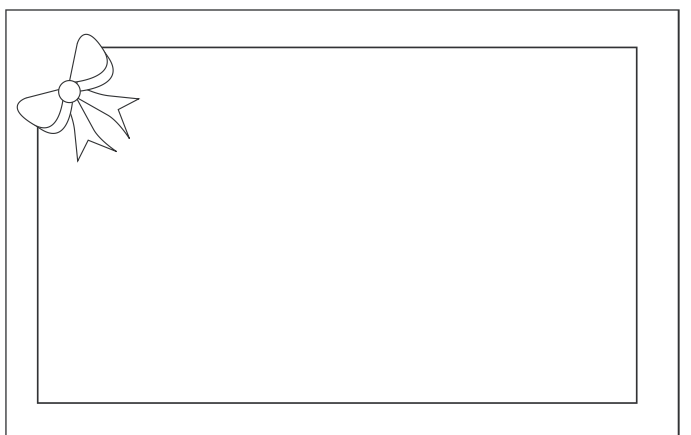

FGBC

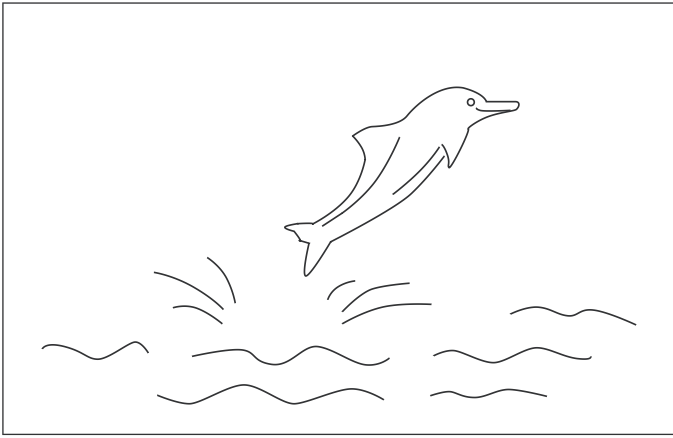

FGBC 513

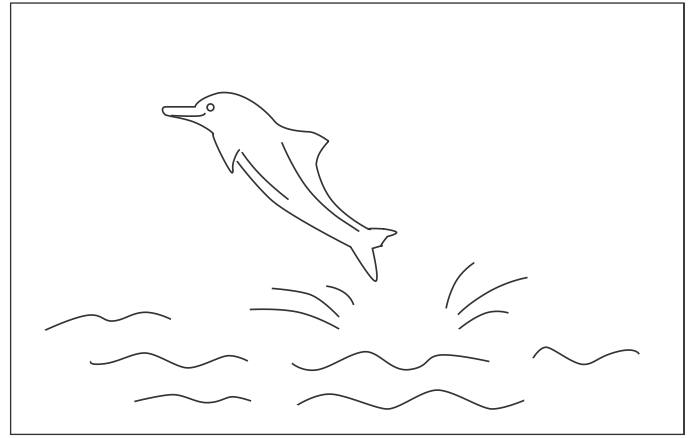

FGBC 514

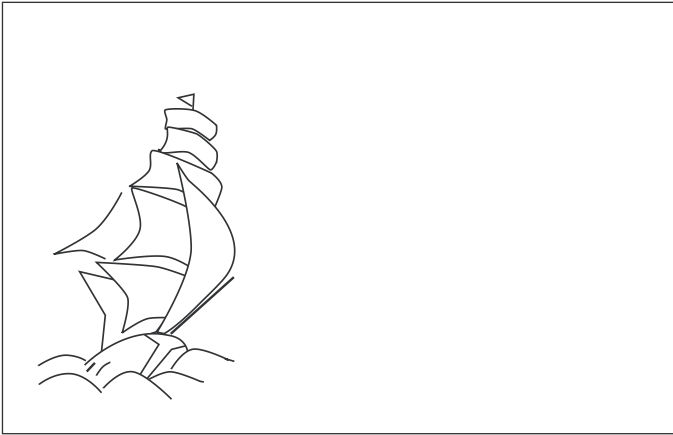

FGBC 515

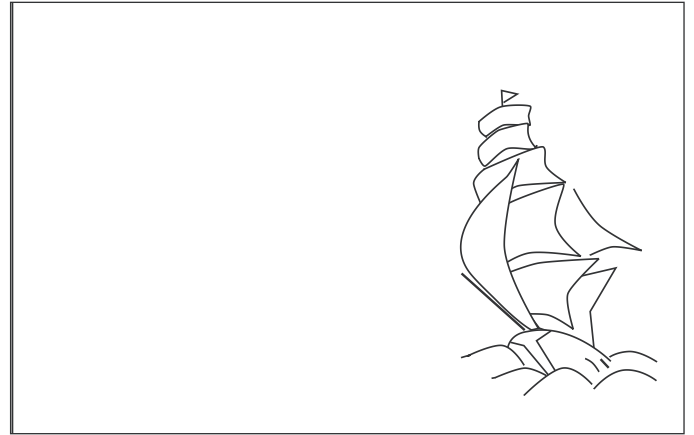

FGBC 516

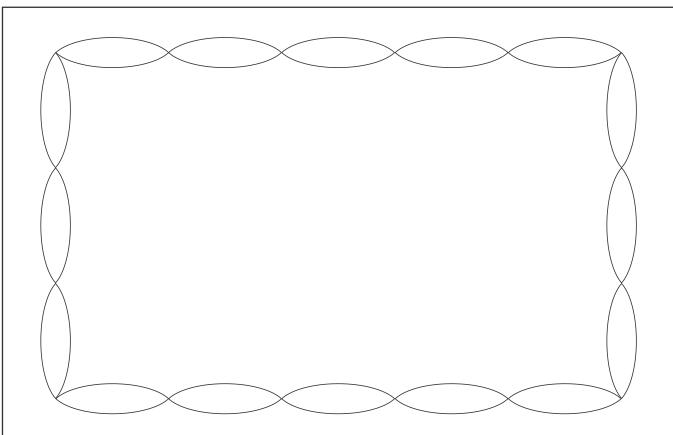

FGBC 517

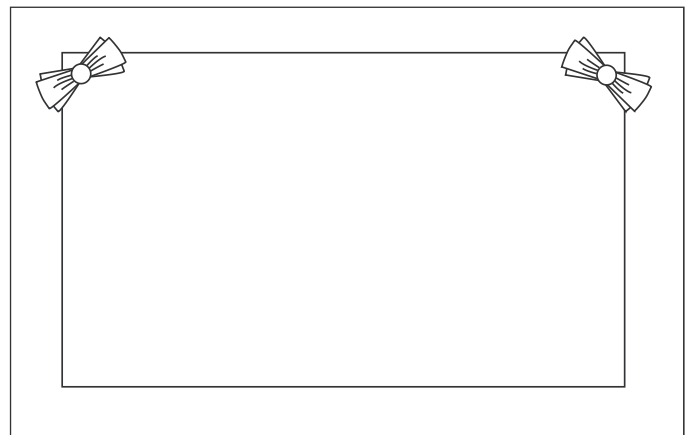

FGBC 518



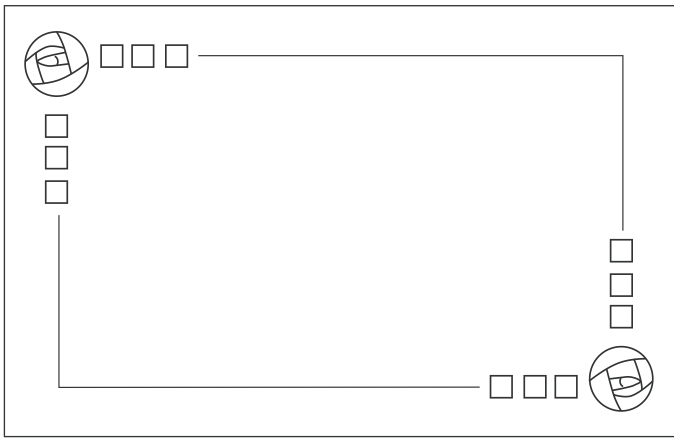

FGBC

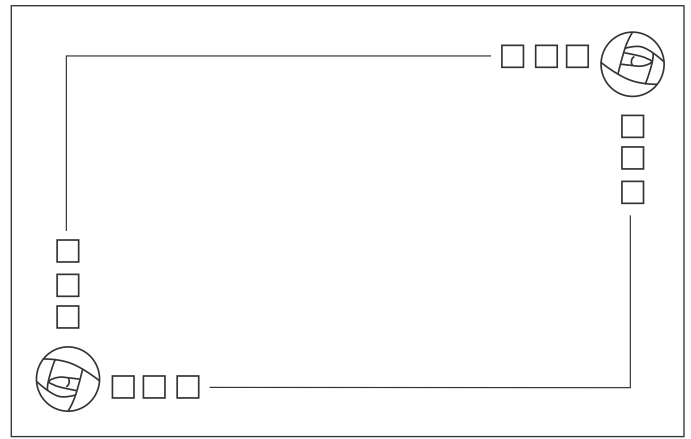

FGBC



FGBC

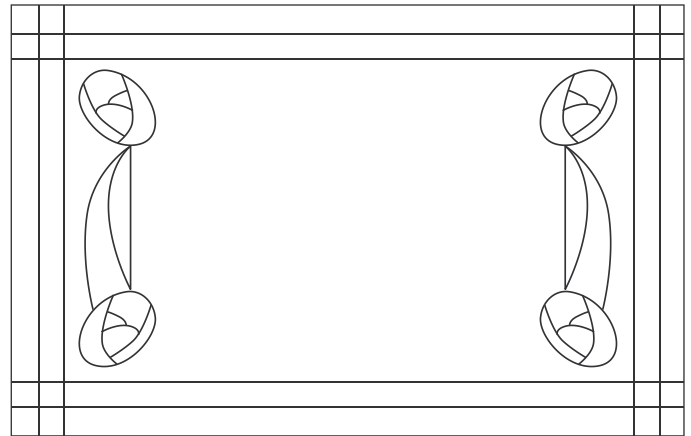

FGBC

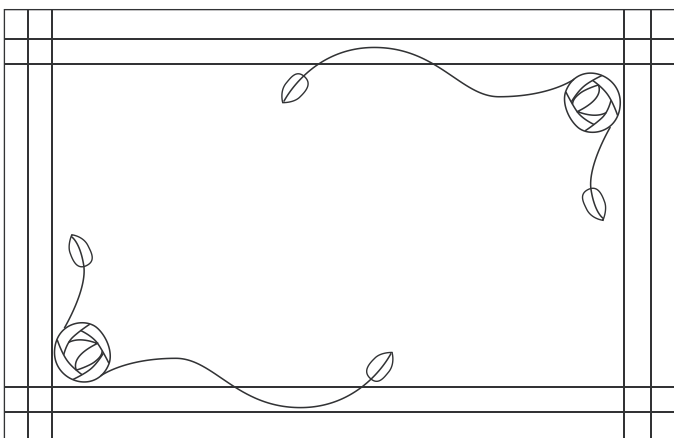

FGBC

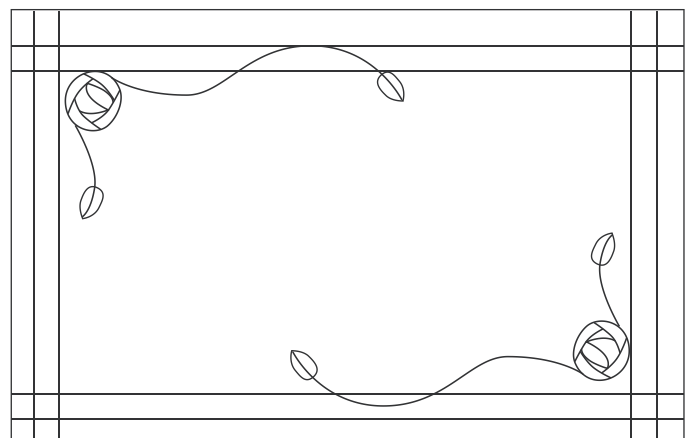

FGBC

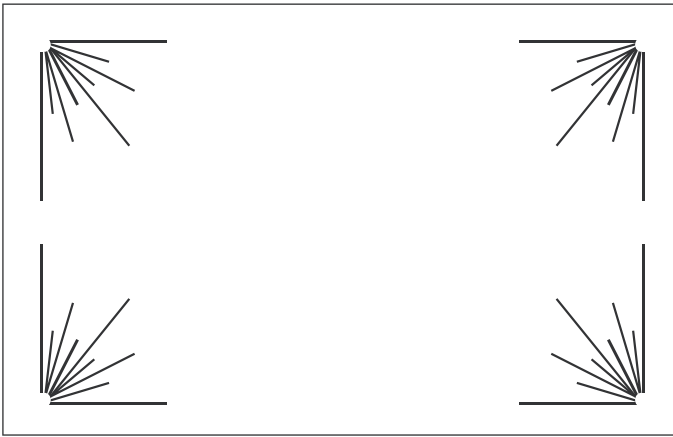

FGBC

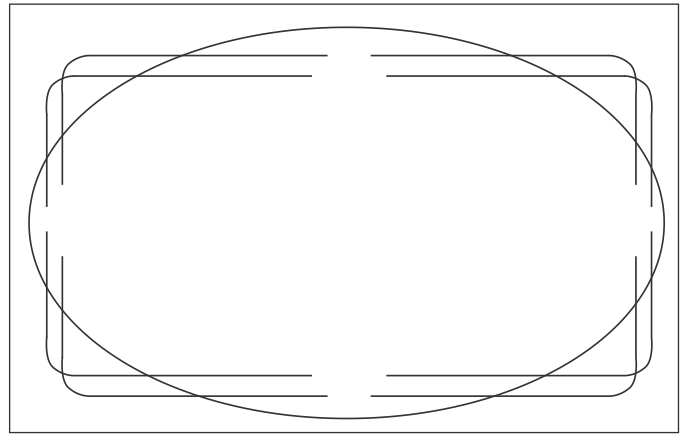

FGBC 525

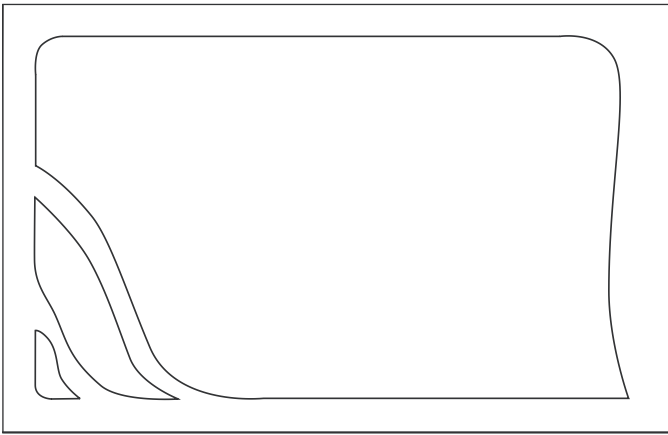

FGBC 526

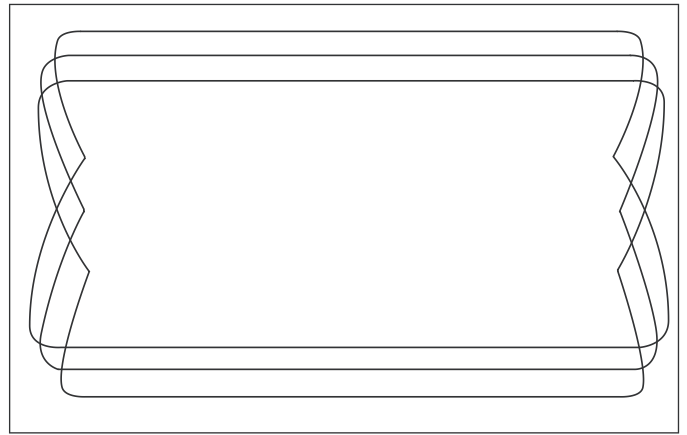

FGBC 528

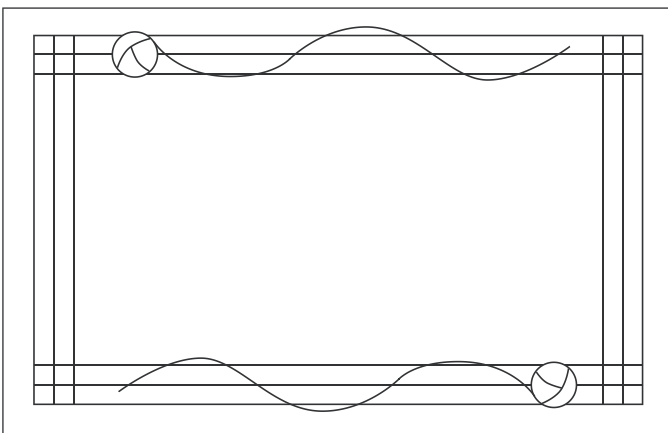

FGBC 529

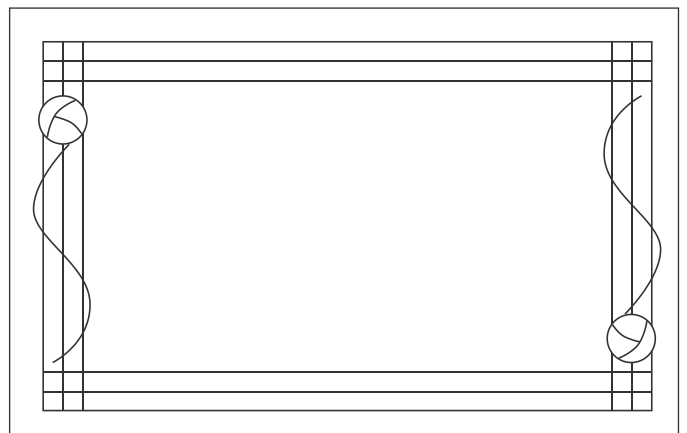

FGBC 530

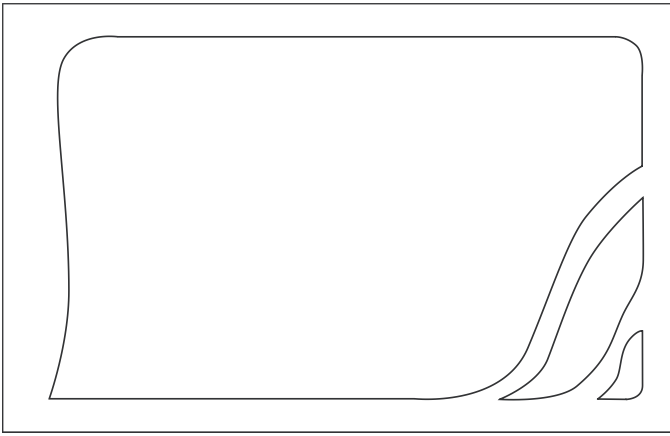

FGBC 531

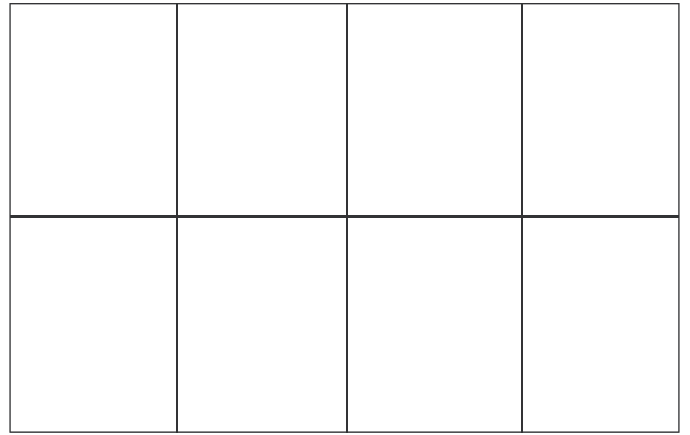

FGBC 534



FGBC 535

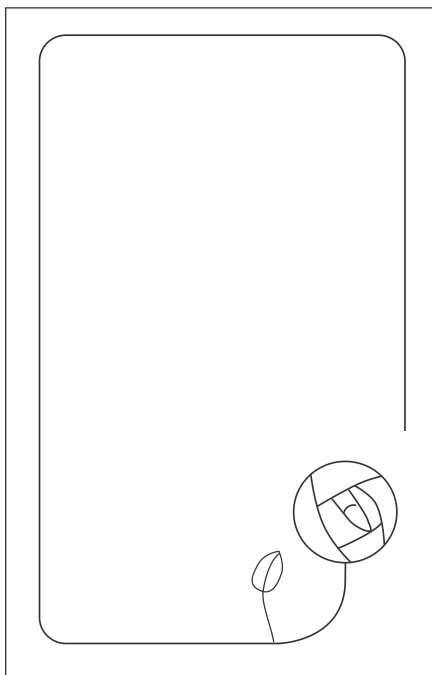

FGBC 527

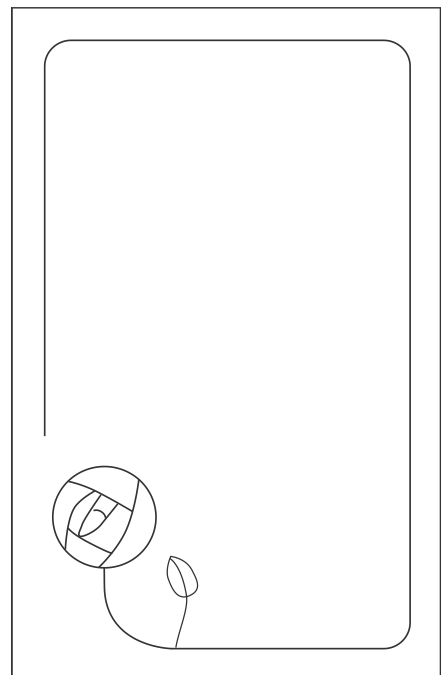

FGBC 532