

Dealer Stamp:

space·pro^o
HARDWARE



CLEVER STORAGE...
FOR ANY ROOM,
IN ANY HOME

SLIDING DOORS
Made to Measure Wardrobe Systems

SLIDING DOORS
Made to Measure Wardrobe Systems



Shaker.
Black and Red glass doors with matching Oak frames.



Shaker.
Walnut and Black glass doors with matching Walnut frames.

A fusion of traditional styling with modern materials to create a stunning array of sliding door options.

Choose from Oak, Walnut or White frames, Designed to epitomise the classic Shaker style, then either compliment with matching wood effect panels or make a bolder statement with a contrasting wood colour or glass panel in any combination. Let your imagination take over.

The Shaker frames are perfectly matched to the wood effect panels. Within the Shaker sliding door range you're able to mix glass and wood effect panels together to create your perfect sliding door design.



Shaker.
Black glass with Oak frame.



Shaker.
Frame

Frame options

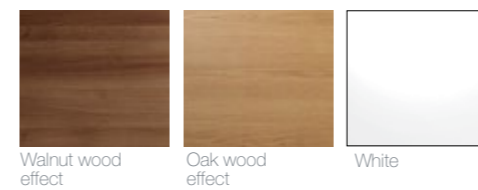

Walnut wood effect Oak wood effect White

Mirror options

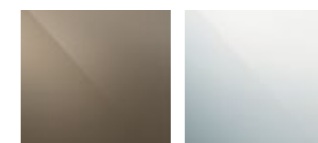

Bronze mirror Silver mirror

Coloured glass options



Red Black Light brown Light beige Pure white Metal grey Soft white Classic grey

Wood effect panel options



Walnut Oak Beech White ash Gloss wallis plum Hacienda Black Hacienda White

Door Designs

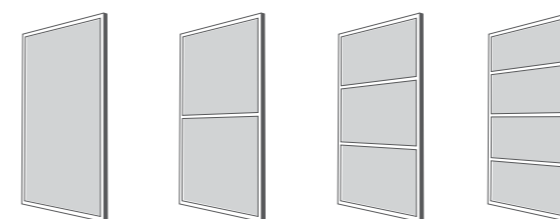

Available as 1,2,3 or 4 panel design



Minimalist.
Gloss wallis plum doors, 4 panel.



Minimalist.
Black glass panel doors, 2 panel.

Our gorgeous Minimalist range is unashamedly Italian influenced and makes a bold statement in any modern home.

Rich glass & wood effect colours add warmth and drama and just ooze luxury. The subtle, brushed aluminium frame is deliberately understated, allowing the coloured panels to dominate the design to a breathtaking effect.



Minimalist.
Red glass doors, 4 panel.

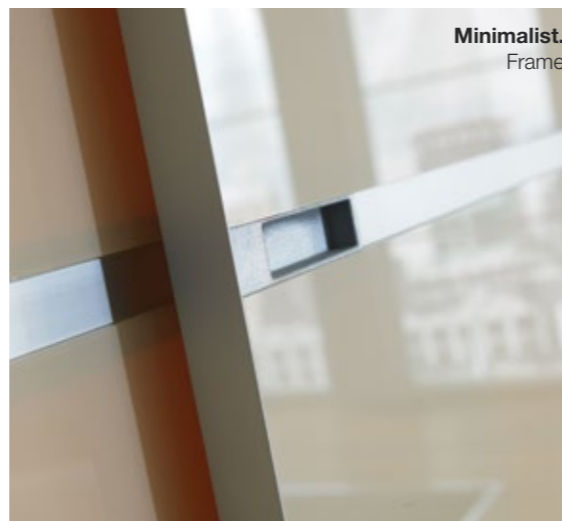

Minimalist.
Frame

Mirror options

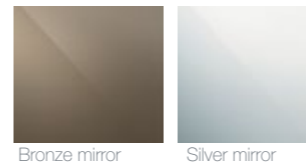

Coloured glass options



Wood effect panel options



Door Designs

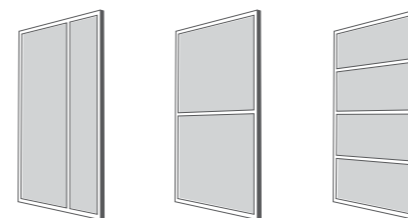

Available as a 2 & 4 panel design only

It's surprisingly easy to install a Made to Measure sliding wardrobe system

Simply measure the space you're going to use for your wardrobe, give us your measurements and we'll make your doors and track sets to just the right size. Fit your bottom track, then the top one and pop the doors into the track. That's it. A beautiful and stunning wardrobe in a few simple steps.



Traditional.
Oak and Soft white glass doors with matching Oak frames.



Traditional.
Frame

A fusion of traditional styling with modern materials to create a stunning array of sliding door options.

Choose your frame finish, then either complement with matching wood effect panels or make a bolder statement with a contrasting wood colour or glass panel in any combination. Let your imagination take over.

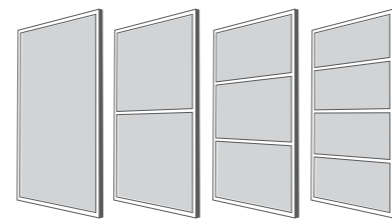

Available as 1,2,3 or 4 panel design

Door Designs and Finishes

Coloured glass options



Mirror options

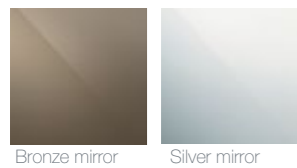

Wood effect panel options

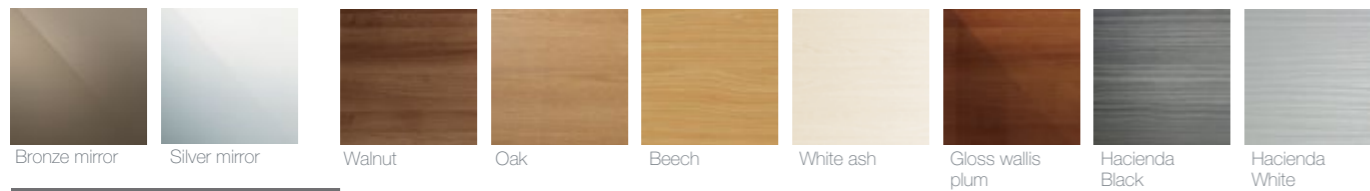

Frame options

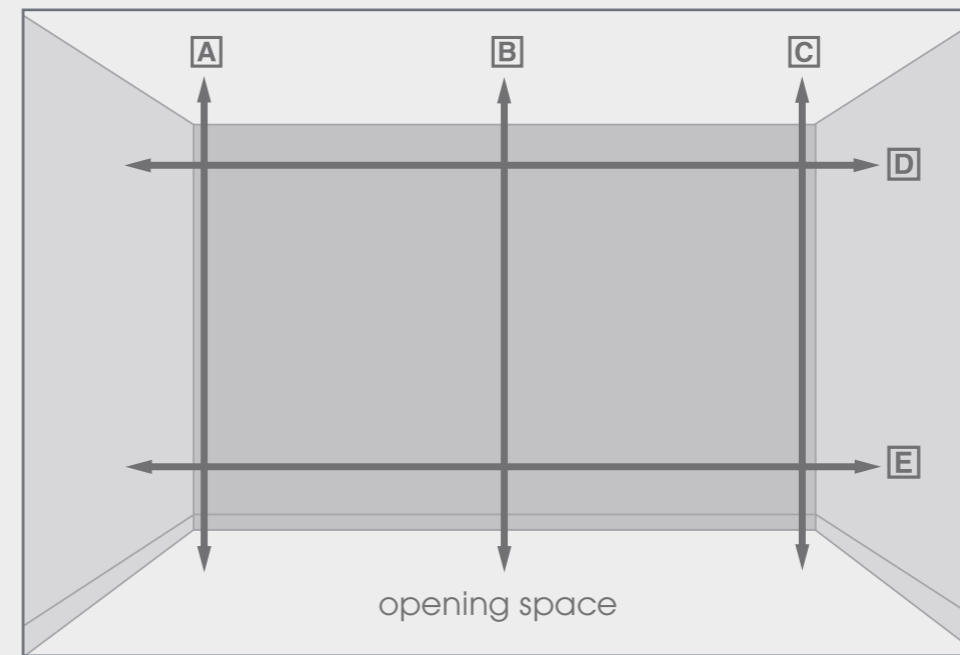
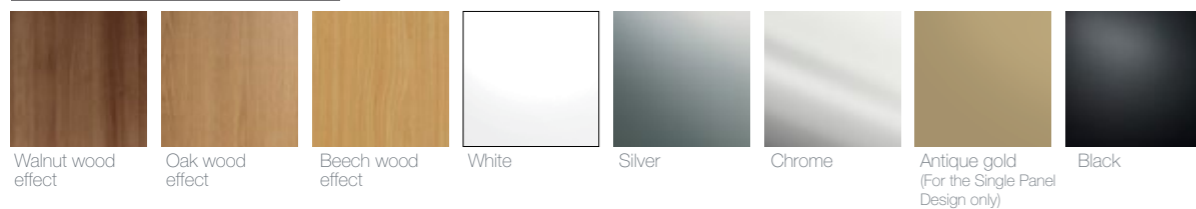

1. Fitting to ceiling and wall to wall.

Measure your opening height and width at the five points indicated on the diagram.

If there is any difference between the measurements of A, B or C, this means that your ceiling and floor are not parallel. Your track sets will allow for a difference of +/- 12mm. Doors will be made to fit the smaller of the 3 height dimensions.

NB. Please take into account any obstruction such as coving, skirting, radiators etc. and either remove them or build an unobstructed opening around them.

Walls should be as vertical, and parallel, as possible. Adjustment in the door will allow for out of square openings up to 20mm maximum. Doors will be made to fit the larger of the 2 width dimensions.

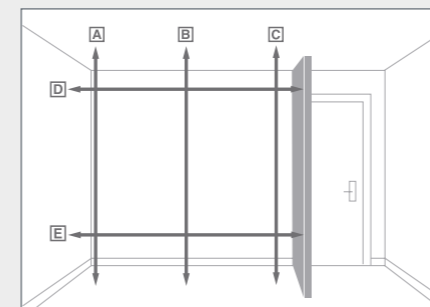

2. Fitting to a doorway or window opening.

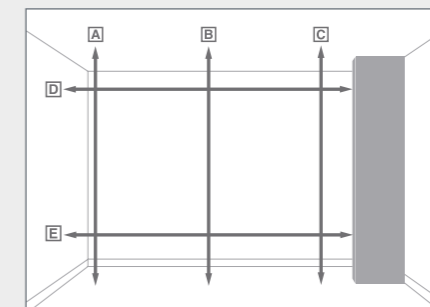

3. Fitting with a side panel.

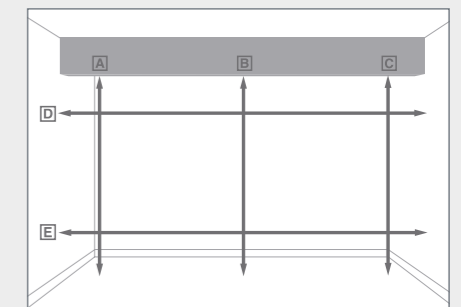

4. Reducing your ceiling height (if room is higher than 2480mm).